

Owner's manual

458 SPECIALE



Important note



For information on where to find FERRARI DEALERS and AUTHORISED SERVICE CENTRES, visit the website www.ferraridealer.com or contact the Customer Care service on the numbers indicated in the “Reference Guide” booklet.





General remarks

This vehicle, which complies with EC homologation parameters, uses advanced technology and is capable of achieving high performance levels.

It is equipped with sophisticated active and passive safety systems (described below).

These safety features and systems do not authorise the driver to take risks other than those involved in normal driving since their preventive and protective action is guaranteed only in certain conditions. Unless otherwise instructed specifically by **FERRARI** (see the Safety chapter), the deactivation of any of the vehicle's safety systems is **PROHIBITED**.

While certain safety systems (e.g. the airbags) have been tested to ensure that they offer the highest possible levels of protection, they may nonetheless be hazardous in the event of failure by the driver or passenger to observe the instructions given by **FERRARI**. All vehicle occupants must be attentive at all times and take particular care when transporting passengers who are more subject to injury such as children, disabled and elderly persons.

Safe driving is subject to the following conditions **AT ALL TIMES**:

- the driver must be in perfect psycho-physical condition;
- road regulations (Traffic Regulations - Vienna Convention on Road Traffic that ended on 8 November 1968) must be strictly observed;
- common rules of caution must always be observed in relation to the quality/performance of the vehicle, driving conditions and contingent situations.

- Caution and discipline are the basis of safe driving.
- Driving takes place in a naturally dangerous context where a number of different risk factors interact. For this reason, it is important to drive bearing in mind that others, whether they are pedestrians, motorcyclists or motorists, can make mistakes. Keeping a safe distance allows emergency measures to be taken. Remember that national and international legislation requires that the driver of the vehicle must be capable of performing corrective and/or emergency manoeuvres at all times.
- Correct and careful use of a vehicle derives, above all, from respect for one's own safety and that of others as well as from compliance with road regulations. Only this respect will help you experience all the emotions that driving this car can offer you.

The driver **MUST NEVER** allow passengers to increase the risks associated with driving (e.g. by not using safety systems such as the seat belts) by failing to observe the mandatory safety rules that apply to both driver and passengers.

The vehicle **MUST NOT** be modified or tampered with for any reason whatsoever since, by so doing, the manufacturer's homologation and safety parameters will be modified.



The driver must pay the utmost attention to the signals of the vehicle and, in particular, the warning lights on the dashboard and buzzers. Even when the warning lights do not indicate a situation of immediate danger, the driver must be cautious in relation to possible consequences/degeneration of the failure and other information given.

During routine operations, such as refuelling, precautions should always be taken and it is important to check that flammable liquid has not been spilled; these precautions must be observed even if the operation is performed by others. Similarly, before setting off make sure that the doors are closed by checking the warning lights and also manually. The driver must be fully acquainted with the vehicle and its controls in order to handle and drive it correctly. Command of the vehicle can be acquired/improved by attending the driving courses held by **FERRARI** which we strongly recommend.

The use of terms from the motor sports world (such as F1, SPORT and RACE) is merely indicative of the vehicle's competition-derived technology and does not endorse inappropriate behaviour on the road which does not comply with Traffic Regulations.

While this vehicle has features that may be used on the track, it is a road-going vehicle and is not suitable for continuous use on the track.

Most accidents are caused by distraction. The driver must use any on-board information, communication and entertainment systems responsibly, especially when the vehicle is in motion.

Examples of information, communication and entertainment systems are the following: satellite navigation systems, traffic information systems (e.g. ITT), media players (e.g. iPod), telephones with Bluetooth connectivity, etc. (whether merely audio-based or with display).

It is important to bear in mind that on-board systems may be distracting when driving since they may take a driver's attention away from the road for several seconds. Aftermarket video entertainment systems for the passenger (e.g. TV) must be installed where they cannot distract the driver while the vehicle is in motion. While the vehicle is in motion, the attention required to use on-board systems must never exceed the high level of attention required to drive safely in accordance with the Traffic Regulations.

Therefore, these systems may only be used (separately or in combination with others) by the driver:

- in complete safety (stopping the vehicle before use if necessary). Operations that are not involved with driving (e.g. changing dashboard functions), must be performed in maximum safety when the vehicle is stationary;
- putting road safety first; for example, under conditions of poor or limited visibility, looking at a display with active programmes can be distracting even if you take your eye off the road only for a split second;



- ensuring, if the previous vehicle owner has installed systems on the vehicle that are **NOT APPROVED** by **FERRARI** (car tuning), that they are fully compatible with the original vehicle equipment.

If the vehicle owner has installed one or more new systems, either fixed or removable, on the vehicle, make sure that these

- have the necessary certification;
- are fully compatible with the original vehicle equipment (i.e. they do not interfere with it);
- are fitted by skilled staff.

The **FERRARI TECHNICAL SERVICE DEPARTMENT** and **FERRARI DEALERS** and **AUTHORISED SERVICE CENTRES** can provide all the information needed to ensure that they are compatible.

Strict priority criteria must be observed when driving a vehicle: you must not therefore take your attention and eye off the road.

In some countries, the use of entertainment/information systems is prohibited on vehicles when driving.

The driver is responsible for use of these entertainment/information systems with video screens if they are prohibited in the country where the vehicle will be driven.

These considerations are not exhaustive, but only refer to a number of general issues that will be specifically dealt with in this Owner's Manual.



Introduction

The aim of this Owner's Manual is to help you get the best value from your vehicle and to provide information on routine maintenance: we advise you to read it carefully before setting out. The Owner's Manual should be considered an integral part of the vehicle and must therefore always be kept on board.

Using the vehicle in a way that does NOT comply with the Owner's Manual not only exonerates **FERRARI** of any responsibility but also puts the person at great risk.

Updating

The high quality level of the vehicle is subject to constant technological improvements. Therefore, there may be differences between this manual and your vehicle.

The **FERRARI SALES AND SERVICE NETWORK** will provide you with all the information on any updates.

All specifications and illustrations contained in this manual are accurate as of the date of printing.

Spare parts

When replacing parts or topping up with lubricants and fluids, we recommend that you use original spare parts and lubricants and fluids recommended by **FERRARI**.

Warranty Booklet

Each new vehicle comes equipped with a "Warranty Booklet".

This contains the vehicle's warranty validity conditions.

This warranty does not affect the buyer's statutory rights as a consumer, which derive from binding legal norms in his or her favour, in the various states or countries or from European Union regulations, towards the Dealer.

The Warranty Booklet also contains the routine maintenance indicated in the "Maintenance Schedule".



Service

The information in this manual is necessary for the use and proper care of the vehicle. In addition, Customers will get maximum satisfaction and results from the vehicle if they carefully follow the instructions contained in it.

We recommend that you have all the checks and services performed at **FERRARI AUTHORISED WORKSHOPS** since they have highly skilled staff and the necessary equipment.

In the case of erroneous maintenance or repairs (that do not conform to the technical repair standards and procedures adopted by **FERRARI**), undertaken by independent repair centres, particularly if concerning safety systems or safety, **FERRARI** may decide to not carry out further repairs on the vehicle, unless the vehicle is restored so that it conforms to original parameters.

The Customer Care Service, available at the numbers indicated in the “Reference Guide” booklet enclosed with the vehicle documents, can provide information on the location of the **FERRARI DEALERS** and **AUTHORISED SERVICE CENTRES**.

The **FERRARI TECHNICAL SERVICE DEPARTMENT** is at your complete disposal for any information and advice. If you have any doubts about the information provided in this manual or how to use or operate the vehicle, please contact the **FERRARI SERVICE NETWORK**.

Consulting the manual

To facilitate reading the manual, the topics have been divided into sections and chapters.

1. General

Provides general information about your vehicle.

2. Safety

Describes the main safety systems in the vehicle.

3. About your Vehicle

Provides all necessary information for use of the vehicle.

4. Advice for Emergency Situations

Provides useful advice for solving problems that may occur.

5. Care of the vehicle

Provides advice for cleaning, care and routine maintenance of your vehicle.

6. Glossary

Explains the main technical concepts.

7. Table of Contents

Allows you to quickly identify and locate the information required.



Within the various sections, special attention must be paid to the parts marked as follows:

Warning



Extreme caution required: failure to comply with the instructions could constitute a serious risk to personal safety and vehicle protection!

Important note



Important note: a note containing instructions or information.

Environment



Warning for environmental protection: useful advice for protection of the environment.

Abbreviations/Acronyms

Some descriptions and terms with particular meanings are found in this manual in an abbreviated form:

AC	AIR CONDITIONING
ABS	ANTI-LOCK BRAKING SYSTEM
ASR	ANTI-SKID REGULATION during acceleration
DCT	DUAL CLUTCH TRANSMISSION
EBD	ELECTRONIC BRAKE-FORCE DISTRIBUTION
ECU	ELECTRONIC CONTROL UNIT
ESC	ELECTRONIC STABILITY CONTROL
F1-Trac	Traction control derived from the technologies used in the racing sector.



Environmental protection

Environment



The following chapter contains useful advice for environmental protection.

FERRARI has designed and constructed a vehicle using technologies, materials and devices capable of reducing the harmful impact on the environment to a minimum.

If you use your vehicle with respect for the environment, you too will contribute towards environmental protection.

Fuel consumption as well as engine, gearbox, brakes and tyres wear mainly depend on two factors:

- use of the vehicle
- driving style.

Both factors are influenced by the driver.

Use of the vehicle

- Avoid using the vehicle for short trips.
- Check that the tyre pressure is correct.
- Check the fuel consumption.
- Proper periodic maintenance will contribute to preserving your vehicle in full working order and to protecting the environment. We therefore advise you to respect the service due dates indicated in the “Maintenance Schedule”.

Driving style

- Do not accelerate during the starting procedure.
- Do not warm up the engine when the vehicle is stationary.
- Drive carefully and keep a safety distance that corresponds to the driving speed.
- Avoid sudden and frequent acceleration or braking.
- Turn off the engine if the vehicle is kept stationary for long periods of time.
- Shift gears using only 2/3 of the speed permitted for each gear.
- Use the air conditioning in moderation.

Important note



The vehicle is equipped with exhaust gas control and monitoring systems which must always be kept in perfect working order and controlled regularly.



Directive for the treatment of end-of-life vehicles (EU only)

For many years, FERRARI has been globally committed to respecting and protecting the environment by constantly improving its manufacturing processes and developing increasingly eco-compatible products.

Regulations for the treatment of end-of-life vehicles, implemented in response to the terms of EU Directive 2000/53, require that producers (manufacturers and official importers) collect all the vehicles introduced on the market by the producers themselves at the end of their life cycle, and ensure that these vehicles are processed in an environmentally compatible manner.

To hand over your FERRARI at the end of its life cycle for treatment at no additional cost (excluding deregistration and transport), take your vehicle to the nearest FERRARI dealer, which will, at its own expense, transport the vehicle to one of the authorised collection and demolition centres, which have been selected to ensure that all processes for the collection, treatment and recovery of recyclable materials are carried out in an environmentally compatible manner.

For further information, visit the website www.ferrari.com.

When handing over a FERRARI vehicle at the end of its life cycle:

- the vehicle must be complete, containing all the essential elements such as the engine, transmission, bodywork, ECUs and catalytic converters;
- the vehicle must not contain any additional refuse.

FERRARI is committed to offering its clients a geographically extensive and, as a result, better service, and thanks you for your cooperation in this environmental challenge.

Vehicle keys	14
Alarm system.....	15
Duplicating the keys	16
Replacing remote control batteries	17
Electronic alarm	17
Identification and homologation plates and labels ..	20
Dimensions and weights	26
Main engine specifications	27
Consumption and emissions	27
Performance.....	27
Wheel rims and tyres.....	28
Refilling.....	34



1



GENERAL





Vehicle keys

The vehicle is delivered with two identical keys that can be used for:

- central door locking;
- starting the vehicle;
- activating/deactivating the alarm system;
- opening the luggage compartment lid.

Important note



If the keys are lost or stolen, you can request a duplicate from the **FERRARI SERVICE NETWORK** (see “Duplicating the keys” on page 16).

Key codes

A **CODE CARD** is supplied together with the keys, indicating the following:

- the electronic code;
- the mechanical code for the keys, to be given to the **FERRARI SERVICE NETWORK** if you request duplicates of the keys.

Warning



The code numbers on the **CODE CARD** must always be kept in a safe and protected place, not accessible to others.

Important note



In the event of a change of ownership, it is essential that the new vehicle owner is provided with all the keys and with the **CODE CARD**.





Alarm system

The FERRARI CODE system

The vehicle is equipped with an electronic immobiliser system (FERRARI CODE) which is automatically activated when the ignition key is removed.

The keys are equipped with an electronic device which transmits a coded signal to the FERRARI CODE ECU. Once this ECU has recognised the signal, it allows the engine to start.

Operating

Each time the ignition key is removed (see page 77), the protection system activates the engine immobiliser.

- When starting the engine, press the **ENGINE START** button on the steering wheel:

- 1) If the code is recognised, the **CODE** warning light **A** on the instrument panel turns off when the check procedure has been completed, whereas the **EOBD** warning light **B** turns off when the engine is started once the ECU has completed its diagnostic cycle; in these conditions, the protection system has recognised the key code and deactivated the immobiliser.
- 2) If the **CODE** warning light **A** stays on, it means that the code has not been recognised. If this occurs, it is advisable to turn the key back to position **0** and then back to **II**; if the immobiliser device remains active, try with the other key provided.

1

Important note



If you still cannot restart the engine, contact the **FERRARI SERVICE NETWORK**.

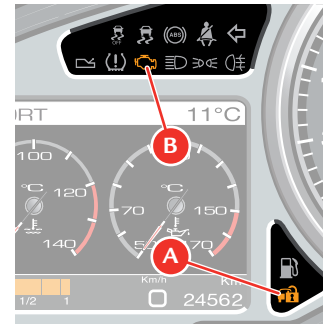



- While driving, with the ignition key in position **II**:

- 1) If the **CODE** warning light **A** turns on, it means that the system is performing a self-diagnostic cycle. At the first opportunity, you can stop and test the system: switch off the engine by turning the ignition key to position **0**, then turn the key back to position **II**. The **CODE** warning light **A** will turn on and should go off within one second. If the warning light stays on, repeat the procedure described previously leaving the key at **0** for more than 30 seconds.

Important note



If the problem persists, please contact the **FERRARI SERVICE NETWORK**.

- 2) If the **CODE** warning light **A** flashes, it means that the vehicle is not protected by the immobiliser.

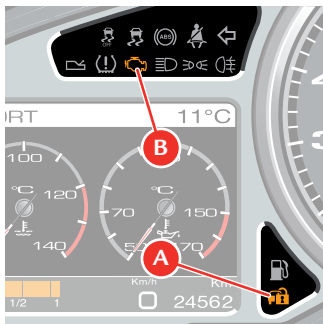

Important note



Contact the **FERRARI SERVICE NETWORK** immediately to have all the keys stored in the system memory.

Important note



Each key provided has its own specific code, which must be stored in the memory of the system control unit.

Duplicating the keys

If you request additional keys, provided that the conditions to satisfy your request are met, remember that the codes must be stored (up to a maximum of 7 keys) on all the keys. Contact the **FERRARI SERVICE NETWORK** directly and bring the following with you:

- all the keys in your possession;
- the **CODE CARD** for the **FERRARI CODE** system;
- a personal identity document;
- the documents proving ownership of the vehicle;
- a report of loss of keys made to the relevant authorities.

The codes for the keys that are not available when the new memorisation procedure is performed will be deleted from the memory to prevent any lost or stolen keys being used to start the vehicle.



Replacing remote control batteries

If you press one of the three buttons of the key and this does not activate the corresponding function, check that the alarm system functions are operating correctly by using the other remote control before replacing the two batteries.

Replace the remote control batteries as follows:

- open the key cover **C** using a small screwdriver at the position indicated by the arrow;
- remove the two batteries **E**, pushing in the direction indicated by the arrow to release them from the retainer cover **D**;
- fit two new batteries of the same type, observing the indicated polarity;
- close the key cover **C**.

Important note



Do not use sharp tools to remove the cover and be careful to avoid damaging the remote control.

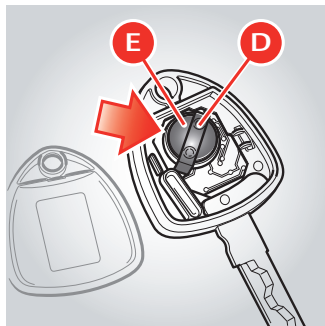
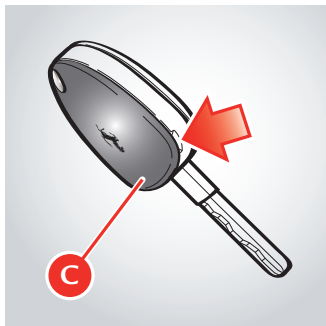

Electronic alarm

The electronic alarm system performs the following functions:

- remote control for central door locking/unlocking;
- perimeter surveillance, detecting if doors and lids are open;
- motion surveillance, detecting intrusion in the passenger compartment;
- vehicle movement surveillance.

Activation

To activate the alarm system, press button **F** on the ignition key:

- the turn indicators flash once;
- the system “beeps”;
- the red LED on the dashboard flashes;
- the central door locking system of the vehicle is activated and the doors are locked.

The system activates after approximately 25 seconds.

When the electronic alarm is activated, the user may request opening of the luggage compartment; in this case, the motion and anti-lift sensors are temporarily deactivated.

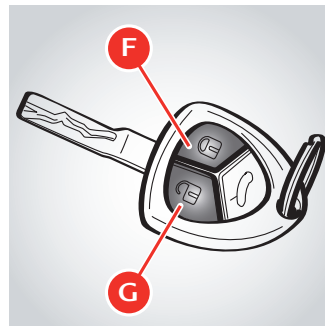

1



If the luggage compartment is then closed, the sensors will be reactivated.

If the turn indicators and the red LED on the dashboard flash 9 times when you activate the alarm system, it means that one of the doors or the front/rear lid is open or not closed properly and is therefore not protected by the perimeter surveillance. If this is the case, check that the doors and front/rear lids are closed properly and close any door or lid that is open without deactivating the alarm system: the turn indicators will flash once to indicate that the door and front/rear lids are now closed properly and protected by the perimeter surveillance.

Warning



If the turn indicators and the red LED on the dashboard flash 9 times when the alarm system is activated with the doors and front and rear lids properly closed, it means that the self-diagnostic feature has detected a malfunction in the system. Contact the FERRARI SERVICE NETWORK to have the system checked.

Deactivation

To deactivate the alarm system, press button **G** on the ignition key:

- the turn indicators flash twice;
- the system beeps twice;
- the red LED on the dashboard goes off;
- the dome lights come on;
- the central door locking system of the vehicle is deactivated and the doors are unlocked.

Pressing button **G** twice unlocks the doors and also turns on the low beams for 30 seconds.

The alarm system is off and you can now get into the vehicle and start the engine.

To enter the vehicle if the remote control battery is flat, insert the key into one of the two door locks and turn it to release the lock; the alarm siren will activate.

Start the vehicle following the standard procedures; The alarm siren will deactivate.

Deactivating the anti-lift alarm

Press button **H** on the roof panel to deactivate the anti-lift alarm system. When this function is deactivated, the indicator light on the button will flash for about 3 seconds and will then turn off.





Alarm memory

If, when the vehicle is started, the **CODE** symbol (see page 104) appears on the left TFT display for 10 seconds after the system diagnosis cycle, together with the message “Break-in attempted”, this means there has been an attempt to break into the car, causing the alarm to activate.

In this case, the system will indicate the reason for the alarm activation according to the following priority:

- **LED off twice:** anti-lift sensor alarm;
- **LED off three times:** door alarm;
- **LED off four times:** luggage compartment lid alarm;
- **LED off five times:** ignition key alarm.

The alarm system memory is reset by turning the ignition key.

Ministerial homologation

The electronic alarm system complies with EU (European Union) regulations on electromagnetic compatibility and it is marked accordingly.

The homologation number is referred to with the following characters.

For those markets that require the transmitter and/or receiver marking, the homologation number is found on the component.

Satellite alarm system (optional)

In some markets, the vehicle can be equipped, on request, with a satellite alarm system. If the vehicle is equipped with a satellite alarm system, please refer to the “Nav Trak Satellite Alarm System Quick Reference” booklet enclosed with the vehicle documents, for further information.





Identification and homologation plates and labels

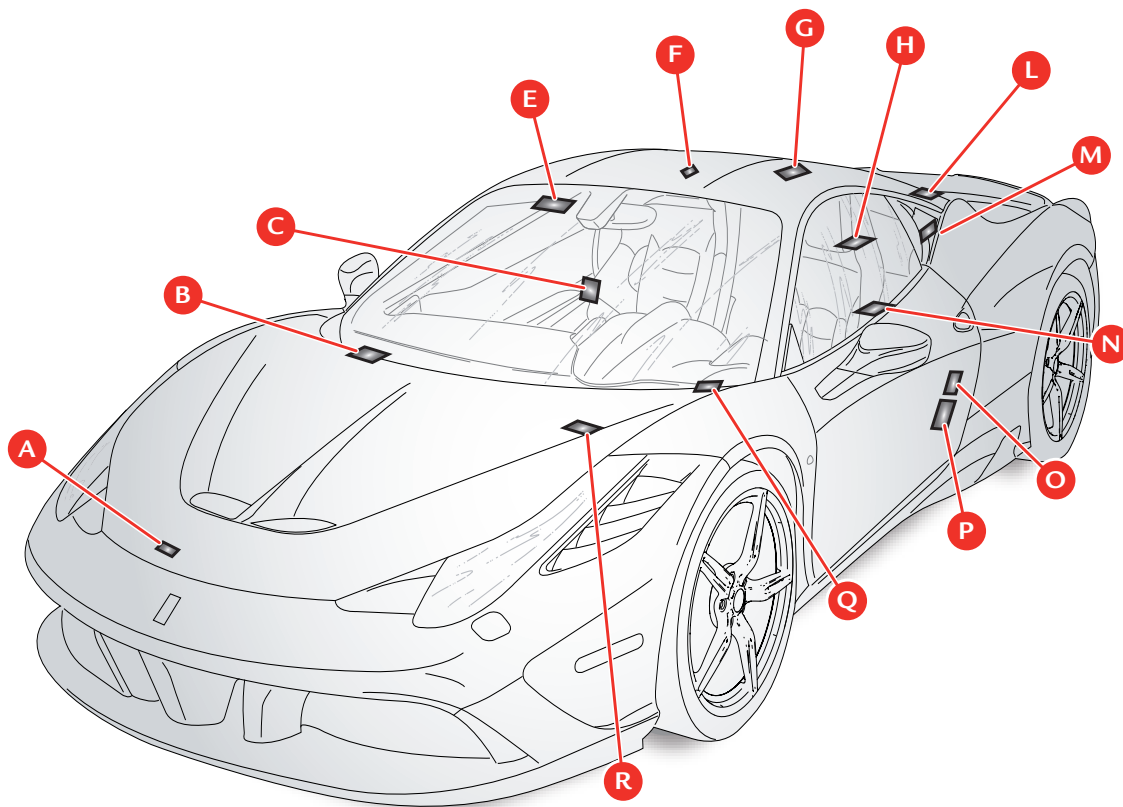



Ref.	Label/plate	Position
A	Low-beam homologation	Luggage compartment lid
B	ECE homologation	Luggage compartment lid
C	Vehicle identification	Rear passenger-side door jamb
E	Passenger airbag warning	Passenger-side sun visor
F	Unleaded fuel	Fuel filler flap
G	Radiator with antifreeze	RH engine compartment cosmetic shield
H	Engine type and number	Crankcase
L	Assembly number	Engine compartment
M	Engine and gearbox oil label	LH engine compartment cosmetic shield
N	Gearbox type and number	Gearbox housing
O	Tyre pressure and type	Driver-side door
P	TPMS present warning	Driver-side door
Q	Chassis number	Windscreen
R	Original paintwork	Luggage compartment lid



A Low-beam homologation



C Vehicle identification



B ECE homologation

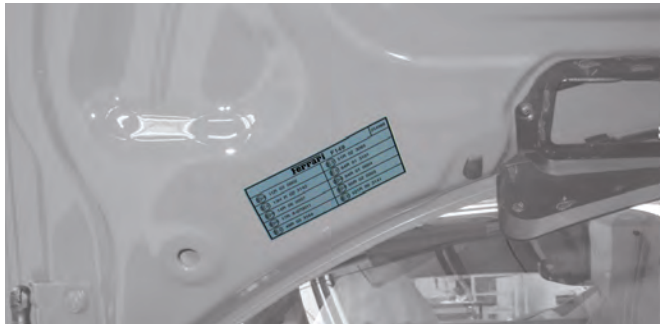



E Passenger airbag warning



G Radiator with antifreeze



1

F Unleaded fuel



H Engine type and number





L Assembly number



N Gearbox type and number



M Engine and gearbox oil label



O Tyre pressure and type

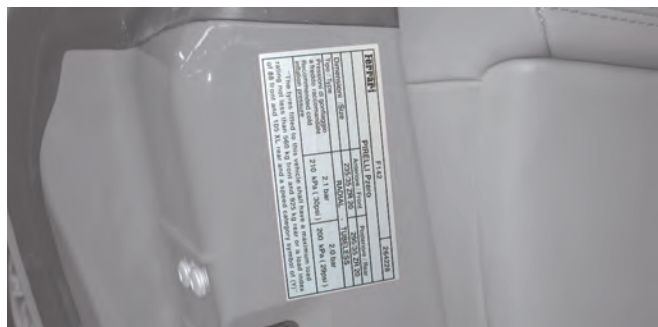



P TPMS present warning

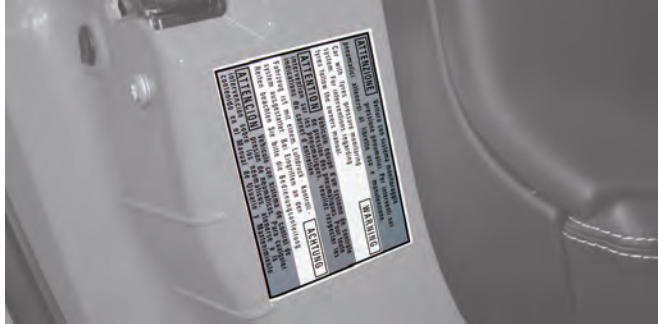

R Original paintwork



1

Q Chassis number





Dimensions and weights

Wheelbase	2650 mm
Max. length	4571 mm
Max. width	1951 mm
Max. height	1203 mm
Front track	1679 mm
Rear track	1632 mm
Front overhang	1131 mm
Rear overhang	790 mm
Kerb weight	1395 kg *

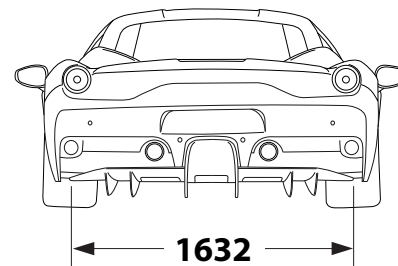
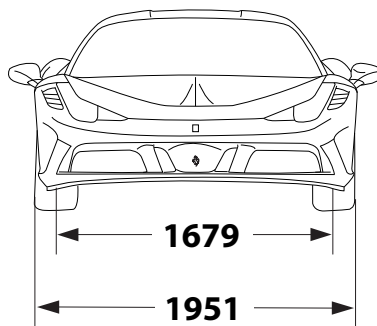

* considering the most favourable Optional combination

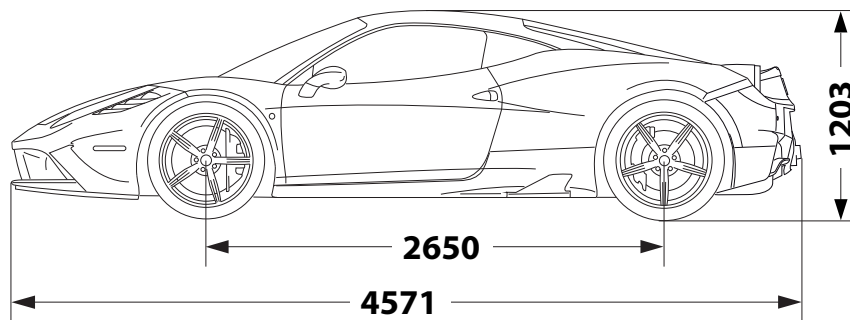



Main engine specifications

Type	F 136 FL
Number of cylinders	8
Cylinder sequence	V 90°
Cylinder bore	94 mm
Piston stroke	81 mm
Total displacement	4497 cm ³
Compression ratio	14:1
Maximum RPM (with limiting device)	9200 RPM
Max. power	444 kW (600 hp)
Corresponding RPM	9000 RPM
Max. torque	540 Nm
Corresponding RPM	6000 RPM

Consumption and CO₂ emissions

	Standard version		With HELE system	
	l/100 km	g/km	l/100 km	g/km
City cycle	19,7	454	15,8	369
Motorway	9,7	223	9,4	221
Combined cycle	13,3	307	11,8	275

Transmission ratios

Gearbox ratios	Differential/bevel gear pair ratio
1 = 3.077	
2 = 2.185	
3 = 1.626	5.143
4 = 1.286	
5 = 1.028	
6 = 0.839	
7 = 0.693	
R = 2.791	

Performance

0 - 100 km/h	0 - 200 km/h	Max. speed
3.0 s	9.1 s	> 325 km/h (202 mph)

Electrical system

Supply voltage	Alternator
12 V	Nippondenso 165 A SC3
Battery*	Starter motor
Optima 12V - 50 A/h RT R 4.2	Bosch

* Fiamm 12V - 70 A/h L3 VRLA 760A EN if the vehicle is equipped with the Stop&Start system (optional)

1



Wheel rims and tyres

Special 458 wheels (not compatible with chains)

Front	Rear	Space saver spare wheel
9" J x 20" ET 44.7	11" J x 20" ET 48.4	4.5" J x 20"

Optional (compatible with chains)

8.5" J x 20" ET 46.5	10.5" J x 20" ET 58.5
----------------------	-----------------------

Warning



Fitting snow chains on wheels that are not compatible with chains may cause damage to the tyre, the wheel and the vehicle.

Explanation of wheel rim codes

Example: **9" J x 20" ET 44.7**

9" = Rim width in inches



J = Shape of rim edge (side projection where tyre bead rests)

20" = Rim diameter in inches



ET 44.7 = Offset (distance, in mm, between the centreline of the rim and inner rim surface)



1

FERRARI-approved tyres			<i>Inflation pressure (cold)</i>	 *	 *	 *
Michelin Pilot Sport Cup 2	Front	245/35 ZR20	2.10 bar	F	C	70 dB
	Rear	305/30 ZR20	2.00 bar	E	C	73 dB

Optional tyres			<i>Inflation pressure (cold)</i>	 *	 *	 *
Vredestein space saver spare wheel		145/60 R20	4.20 bar	-	-	-

Winter tyres			<i>Inflation pressure (cold)</i>	 *	 *	 *
Pirelli Winter Sottozero	Front	235/35 R20 M+S	2.10 bar	E	C	72 dB
	Rear	285/35 R20 M+S	2.00 bar	C	C	73 dB

*: Regulation no. 1222/2009/EC (see page 32)



Explanation of codes and wording on tyre side walls

1) Tyre size and characteristics

Example: **245/35 ZR 20 (105Y)**

245 = Nominal width (distance in mm from side to side)

35 = Height/width ratio as a percentage

ZR = Radial tyre that can withstand speeds above 240 km/h (149 mph). Combined with the specific load and speed code (in brackets), this indicates a tyre that can withstand speeds above 300 km/h (186 mph).

20 = Rim diameter in inches

105 = Load index: numerical code associated with the maximum load permissible on the tyre at a given pressure, at the speed corresponding to the relative index. The maximum load permissible is indicated in kg and pounds in the wording (3).

Y = Speed index

This indicates the maximum speed at which the tyre can withstand the load indicated in the load index.

Speed indexes (ECE-UN 30) are shown in the table below:

Speed Index	Maximum speed (km/h)
M	130
N	140
P	150
Q	160
R	170
S	180
T	190
U	200
H	210
V	240
W	270
Y	300
ZR (... Y)	> 300

The speed index Y, shown in brackets and associated with the abbreviation ZR, indicates a tyre that can withstand speeds above 300 km/h (186 mph).

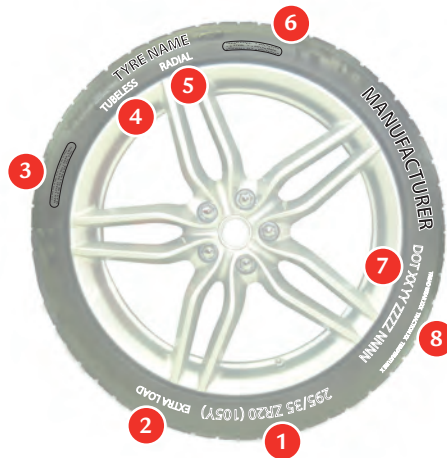



- 2) **EXTRA LOAD:** tyre with a high load capacity
- 3) Maximum load permissible, indicated in kg and pounds, and maximum inflation pressure permissible, indicated in kPa and psi.
- 4) **TUBELESS:** the tyre has no air chamber
- 5) **RADIAL:** radial tyre
- 6) Details of materials used to construct the tread and tyre side wall.
- 7) **DOT XX YY ZZ NNNN**

DOT (Department Of Transportation) specifications: marking relative to US regulations, with information on the manufacturer, production site, tyre type and size. The last four digits, in a box, indicate the date of manufacture: 1011 means that the tyre was manufactured in the 10th week of 2011.

Warning



The **FERRARI SERVICE NETWORK** is suitably equipped to replace tyres, and to determine whether a tyre is safe for use.

Only have the tyres replaced by the **FERRARI SERVICE NETWORK**, which has all the equipment necessary to prevent the risk of damage to the sensor inside the wheel rim, if installed (on vehicles with the TPMS tyre pressure and temperature monitoring system), caused by an inappropriately performed procedures.

- 8) **Uniform Tire Quality Grading:** standard, defined by the US Department of Transportation, that classifies tyre performance in terms of treadwear, traction and temperature resistance.

For further information on tyres, see page 217.

1



Regulation no. 1222/2009/EC (applies to EU countries only)

Regulation no. 1222/2009/EC states that all tyres sold in EU countries produced after 1 July 2012 must bear a label (as shown in the bottom right) containing important information on performance.

The aim of the regulation is to provide consumers with more information on safety (wet grip) and environmental (rolling resistance and external rolling noise) issues in order to promote the use of safer, quieter and more efficient tyres.

The label provides the following information:

Fuel consumption

The fuel consumption of a vehicle is influenced by the tyre rolling resistance. There is a scale with 7 levels, from A to G, on the left of the label where “A” indicates the best tyre class for reducing fuel consumption with lower rolling resistance.

Wet grip

On the right of the label, there is a scale for tyre performance when braking on wet roads. Measurements are taken under test conditions defined in the European Regulation. The scale has 7 levels, from A to G, where “A” indicates the maximum wet grip.

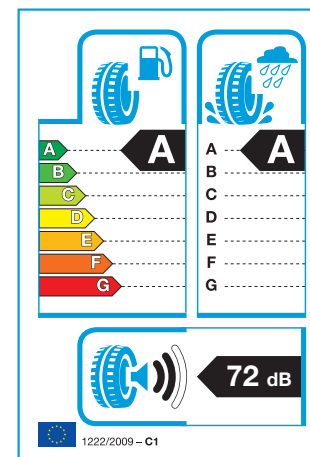



External rolling noise

The bottom of the label indicates the external noise level of the tyre. The external noise level is measured in decibels (dB) and is divided into 3 categories based on the new, stricter European levels of external tyre noise which will be introduced by 2016.

- 1 black sound wave: 3 dB below future European limit
- 2 black sound waves: complies with future European limit
- 3 black sound waves: complies with current European limit.

1



Refilling

<i>Parts to be refilled</i>	<i>Quantity</i>	<i>Fill with:</i>	<i>Ref. page</i>
Engine	Total system capacity	10 l	212
	Oil level between Min. and Max.	2 l	
	Oil consumption	1.0 - 2.0 l/1,000 km	
Gearbox and differential	3.9 l	SHELL SPIRAX S5 ATE 75W-90	213
Clutch system and hydraulic controls	8 l	SHELL DCT-F3	
Braking system	1,0 l	SHELL BRAKE AND CLUTCH DOT4 <i>Ultra</i>	215
Cooling circuit	16.5 l	GLYCOSHELL LONGLIFE at 50% KEMETYL CARIX Premium G30 Longlife at 50%	214
Hydraulic power steering system	1,8 l	PENTOSIN CHF 11S	214
Fuel tank	86 l	Unleaded fuel 95 RON.	78
	Reserve	14 l	
Air conditioning and heating system			
	Compressor	165 cc	PAG ISO 46
	Coolant	630 ± 30 g	DELPHI RL 488 "R 134 A"
Windscreen washer/headlight washer fluid tank	5 l	Mixture of water and glass cleaner	216



Important note



This vehicle is suitable for use with unleaded fuel with a maximum of 10% ethanol (E10).

1

Warning



The use of fuels with 10% to 25% ethanol can lead to malfunctioning.

The use of fuels with over 25% ethanol can cause permanent damage to the engine fuel system.

Passive safety.....	40
Active safety	41
Seat belts	42
How to fasten seat belts.....	44
Pretensioners.....	46
Auxiliary Occupant Protection Systems	48
Driver and passenger airbags.....	49
Side airbags.....	54
Fuel inertia switch.....	57
ABS and EBD	58
Stability and Traction Control	59
Electric parking brake	61
TPMS system.....	62



SAFETY



FERRARI has designed and built a high performance vehicle. In order to take advantage of the safety systems described below, it is essential to comply with the indicated regulations.

Special recommendations

This vehicle has been built to comply with homologation regulations that also concern safety and environmental protection. These high technological standards must always be accompanied by careful and cautious driving.

Particular attention must be paid to:

- Overheated components. High temperatures develop in the engine compartment near the exhaust system. Do not park the vehicle on paper, grass, dry leaves or other flammable materials. They could catch fire if they come into contact with hot parts of the exhaust system. Do not fit other heat shields or remove those fitted on the exhaust system. Do not let flammable substances come into contact with the exhaust system.
- Moving parts of the vehicle such as belts, fans, etc. They must always be adequately protected. Do not remove the guards or operate on the moving parts without taking due precautions.
- Installations under pressure such as braking system, air conditioning system, cooling system and lubrication system may create pressures inside them. Do not perform any operation which may cause gas or liquids to spill out with the risk of injury to persons and damage to things.

Emissions

Warning



- The exhaust gas generated by the running engine may be hazardous, especially when in closed spaces. As well as consuming oxygen, the engine discharges carbon dioxide, carbon oxide and other toxic gases.
- Fuel is highly inflammable and emits vapours which may be noxious if inhaled. Do not use naked flames or create sparks near the open fuel tank or in any other condition where fuel comes into contact with air.

Lubricants

Warning



- The oils used may also be flammable: take the same precautions as those adopted for fuel.

Flammable fluids

Warning



- The fluid in the battery is poisonous and corrosive. Do not let it spill out and come into contact with the skin, eyes or objects. Do not use naked flames or create sparks near the battery.



Fuel inertia switch

- See page 57.

Warning



Seat belts must be worn at all times and must be properly fastened and adjusted!

Correct use of the seat belts can significantly reduce the risk and severity of injury if an accident occurs or if the vehicle overturns.

Warning



For an effective restraining action, the seat belt must be fastened correctly with the seat backrest in the upright position.

The seat belt is fastened correctly when the upper part of the belt crosses the centre of the shoulder (not the neck) and the abdominal section is fitted over the hips (not the abdomen).

Make sure that the belt is not twisted and that it passes closely over your body; if not, in the event of a head-on collision, it may move and cause injury to the abdomen.

Avoid wearing bulky clothing that may interfere with the proper operation of the seat belts.

Warning



Each seat belt has been designed to protect only one occupant. If more than one person uses the same seat belt, the risk of injury in the event of an accident is increased.

Do not sit babies, small children or other persons on your lap.

If there is a collision, the weight of an adult may cause the child to be crushed by the seat belt causing severe or even fatal injuries.

2



Passive safety

The passive safety system has been designed to reduce the risk and severity of injury if an accident occurs.

The vehicle is equipped with the following seat belts:

- 3-point driver's seat belt with pretensioner and load limiting device (see page 42)
- 3-point passenger seat belt with pretensioner and load limiting device (see page 42).

Warning



Auxiliary safety systems are not a substitute for seat belts. All occupants must always wear a seat belt. Correct use of the seat belts combined with use of the auxiliary safety systems provides optimal protection to the occupants in various types of collisions.

The vehicle also has the following auxiliary occupant protection system components (see also page 48 "Auxiliary occupant protection systems"):

- front driver's airbag (for operating functions, see page 50)
- front passenger airbag (for operating functions, see page 50)
- driver's head protection side airbag (head bag) (for operating functions, see page 54)
- passenger head protection side airbag (head bag) (for operating functions see page 54)
- seats (see page 162)
- deformable body

- occupant protection system ECU
- ECU auxiliary sensors
- instrument panel warning light (see page 49)
- inertia switch.

Warning



The protective action of the airbags is always integrated with the seat belts and the pretensioners. The compulsory use of the seat belt is provided by the national regulations (in Italy, for example, by the Codice della Strada, i.e. Traffic Regulations).

Deformable body

The deformable body absorbs shock and distributes it over the entire structure of the vehicle allowing progressive deceleration.

The passenger compartment structure, on the other hand, has been designed to provide maximum resistance without undergoing deformation in order to guarantee a protective survival cell for the occupants.



Active safety

The aim of the active safety system is to reduce the risk of accidents and injury severity.

The vehicle has been designed to provide a high level of safety for whoever uses it. The following systems are specific active safety components:

- braking system
- air conditioning and heating system
- external lights
- buzzer and warning lights (flashing).

The braking system includes the mechanical brake system and the electronic stability and traction control system (ABS and EBD): this is designed to prevent the wheels from locking and to provide good handling and stability.

In some situations, fast acceleration is important to get out of dangerous situations. However, always use the accelerator with extreme caution. During acceleration of the driving wheels, the anti-skid system may help you in certain dangerous situations.

The air conditioning and heating system in the passenger compartment can add to driving comfort and keep you alert so that you can react quickly when necessary.

It is very important to be able to see the road clearly and be seen and external lights must be turned on when the conditions so require.



Seat belts

Statistics show that when used correctly, seat belts reduce the risk of injury in various types of crashes including the risk of ejection from the vehicle and impact with the interior of the vehicle.

If unfastened, the seat belts do not provide any type of protection. Before every trip, always make sure that all occupants are wearing their seat belts.

Warning



Seat belts must be worn at all times and must be properly fastened and adjusted!

Correct use of the seat belts can reduce the risk of serious injury in the event of an accident or if the vehicle overturns.

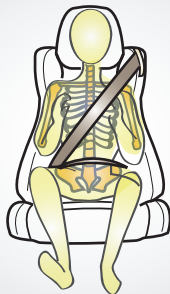

Warning



For an effective restraining action, the seat belt must be fastened correctly with the seat backrest in the upright position.

The seat belt is fastened correctly when the upper part of the belt crosses the centre of the shoulder (not the neck) and the abdominal section is fitted over the hips (not the abdomen).

Make sure it is not twisted and that it passes closely over your body; if not, in the event of a head-on collision, it may move and cause injury to the abdomen.

Avoid wearing bulky clothing that may interfere with the proper operation of the seat belts.

The seat belts have a lap-shoulder belt with an automatic emergency-locking retractor and are fitted with a pyrotechnic-powered pretensioner and an automatic system that reduces the force applied to the occupant.

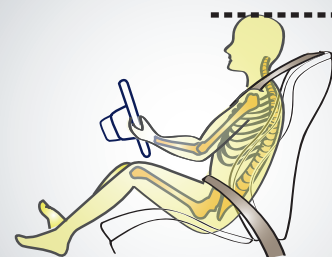



Warning



Do not let the seat belts come into contact with cutting edges. They may get damaged and may consequently break in the event of a collision.

Warning



Each seat belt has been designed to protect only one occupant. If more than one person uses the same seat belt, the risk of injury in the event of an accident is increased.

The seat belt must never be passed around a baby, child or other person sitting on a passenger's lap.

Do not sit babies, small children or other persons on your lap.

If there is a collision, the weight of an adult may cause the child to be crushed by the seat belt causing severe or even fatal injuries.

Warning



Do not attach or pin anything onto the seat belts: they may get damaged and may consequently break in the event of a collision.

Warning



If a seat belt has come into contact with cutting edges or was somehow perforated, we recommend that you have it immediately replaced by the FERRARI SERVICE NETWORK.

Warning



Periodically check the condition of the seat belts. If the belt shows signs of wear, it must be checked by a qualified person and replaced if necessary. Contact the FERRARI SERVICE NETWORK immediately.

Pregnant women

The best protection for pregnant women and their unborn babies is to wear the seat belt correctly. This significantly reduces the risk of injury to the baby. As a result, pregnant women must always wear a seat belt unless specifically directed otherwise by a medical practitioner.

The upper part of the diagonal section of the seat belt must lie snug on the front of the shoulder, pass between the breasts down to the abdomen.

The horizontal strap must sit snugly and as far below the abdomen as possible.



How to fasten seat belts

Warning



For an effective restraining action, the seat belt must be fastened correctly with the seat backrest in the upright position.

The seat belt is fastened correctly when the upper part of the belt crosses the centre of the shoulder (not the neck) and the abdominal section is fitted over the hips (not the abdomen).

Make sure it is not twisted and that it passes closely over your body; if not, in the event of a head-on collision, it may move and cause injury to the abdomen.

Avoid wearing bulky clothing that may interfere with the proper operation of the seat belts.

Once you have adjusted the seat correctly (see page 162):

- Grip the latch plate **A**, slowly pull the belt and insert the latch plate into the buckle **B** (if the belt locks while you are pulling it

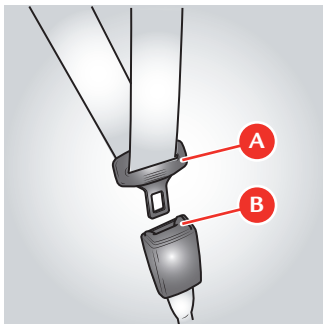

out, let it wind back a little and pull it out again without jerking it).

- Make sure that it has clicked into the locked position: hold the belt and pull it to check that the latch plate has been inserted correctly.
- Position the seat belt correctly.

If the driver's seat belt is not fastened, when you turn the ignition key to position **II**, the warning light **D** on the instrument panel lights up and remains lit until the seat belt is fastened.

55 seconds after a speed of 10 km/h (6 mph) is exceeded, a buzzer sounds warning the driver that the seat belt is not fastened.

When a speed of 20 km/h (12 mph) is exceeded, the buzzer activates immediately and stops after 90 seconds.

This acoustic signal is emitted only once, even if the vehicle speed goes above and below the above mentioned limits. It is repeated (when the vehicle speed is in the indicated ranges) only if the seat belt is fastened and unfastened again or, in any case, every time the engine is turned off and then on.

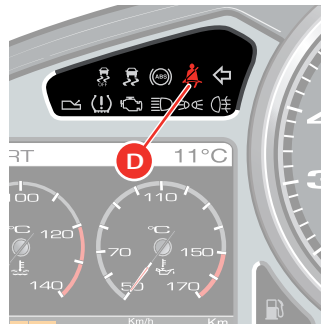



Warning



Each seat belt has been designed to protect only one occupant. If more than one person uses the same seat belt, the risk of injury in the event of an accident is increased.

The seat belt must never be passed around a baby, child or other person sitting on a passenger's lap.

Do not sit babies, small children or other persons on your lap.

If there is a collision, the weight of an adult may cause the child to be crushed by the seat belt causing severe or even fatal injuries.

2

Unfastening the seat belts

- Push the release button **E**.
- Guide the latch plate **A** back to its rest position.

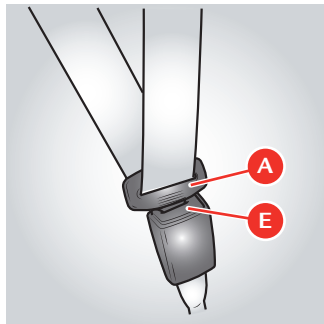



Pretensioners

The seat belts are fitted with pyrotechnic-powered pretensioners. The pretensioner is activated by the airbag ECU when there is a sufficiently severe head-on collision (impact direction between 11 and 1 o'clock p.m.) or a sufficiently severe side collision. The belt will rewind a few centimetres just before the restraining action begins, thereby improving the fitting across the occupant's body. Activation of a pretensioner is signalled by the illumination of the warning light **A** on the instrument panel.

Warning



Pretensioners that have been activated will no longer function and may not be repaired under any circumstances. Contact the FERRARI SERVICE NETWORK for replacement.

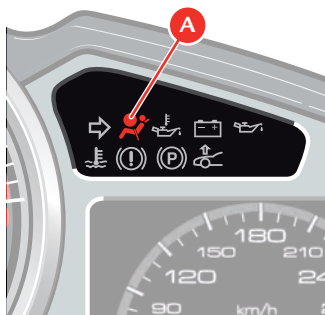

When a pretensioner is activated, a small amount of smoke is released. This smoke is not harmful.

Warning



Activation of the pretensioners only depends on the status of the seat belts and is not affected by the occupants' presence.

If the seat belt is not fastened, the pretensioner will not activate, even if the seat is occupied.

The seat belts are fitted with a load limiting device. The load limiting device is located in the belt retractor and allows controlled release of the belt during a collision thereby limiting the impact that the belt has on the occupant's body.

Maintenance of seat belts and pretensioners

- Following a serious collision, replace the seat belts that were worn at the time even if they do not appear to be damaged.
- Periodically check that the screws on the anchor points are tight and that the seat belt is in perfect condition and slides smoothly.
- The seat belt must be kept clean; the presence of any dirt could prevent the seat belt retractor from working properly.
- To clean the seat belt, wash it by hand with mild soap and water and let it dry. Do not use strong detergents, bleach or aggressive solvents, as they can weaken the fibres.
Make sure the retractors do not get wet: proper functioning is only ensured if they are kept dry.
- The pretensioner requires no maintenance or lubrication.



If immersed in water or mud, it must be replaced.

- Pretensioners must be replaced at regular intervals as indicated in the “Warranty Booklet”.

Important note



All work on any part of this safety system must be performed by the FERRARI SERVICE NETWORK.

Warning



Removing or making modifications of any kind to the seat belts, belt retractors and pretensioners is not allowed.

Maintenance work involving strong impacts, vibrations or heating of the pretensioner area may activate them; vibrations caused by road bumps will not have this effect.



Auxiliary Occupant Protection Systems (driver and passenger)

Warning



Auxiliary Occupant Protection Systems are not a substitute for seat belts but increase their efficiency. Correct use of the seat belts, with the supplementary action of the Auxiliary Occupant Protection Systems, offers maximum protection in the event of a head-on collision or vehicle roll-over.

Auxiliary Occupant Protection System components (driver and passenger)

The Auxiliary Occupant Protection System components are:

- Seat with built-in headrest.
- Dual-stage front driver's airbag.
- Dual-stage front passenger airbag.
- Driver's head protection side airbag (head bag).
- Passenger head protection side airbag (head bag).
- Driver seat belt (with pretensioner and automatic system to mitigate force applied to the occupant).
- Passenger seat belt (with pretensioner and automatic system to mitigate force applied to the occupant).
- Electronic Control Unit (ECU).
- Additional sensors.
- Instrument panel warning light.
- Deformable body.

The front driver's airbag and front passenger airbag have been designed to increase the level of protection given by the seat belts in the event of a head-on collision (see page 49).

The driver's head protection side airbag and passenger head protection side airbag have been designed to increase the level of protection provided by the seat belts in the event of a lateral collision and are situated between the occupant's head and external structures which could penetrate the passenger compartment and cause injury (see page 54).



Warning



The warning light **A** comes on when the ignition key is turned to position **II**. If no malfunctions are detected, it goes out after 4 seconds. If the warning light does not come on, if it remains on or if it comes on while driving, contact the **FERRARI SERVICE NETWORK** immediately.

Driver and passenger airbags

Warning



The front airbags do not provide protection in the event of side-on collisions, some head-on/angular collisions, roll-overs or subsequent collisions (if there is a second collision once the airbags have been deployed in an earlier collision). The seat belts have been designed to reduce the risk of injury in the event of a roll-over or subsequent collision.

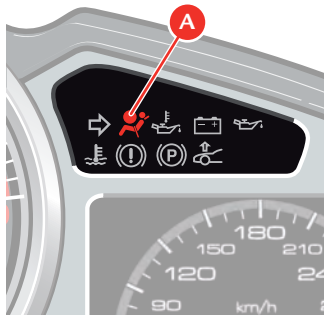

Warning



The front airbags have been designed not to inflate if a minor collision occurs. The seat belts have been designed to reduce the risk of injury if a minor collision occurs.

Warning



The driver and the passenger must maintain a distance of at least 25 cm (10 in.) from the steering wheel and the dashboard. Always drive with your hands on the rim of the steering wheel so that in the event of activation, the airbag can deploy without obstruction.

Driving with your hands on the steering wheel spokes or on the airbag cover increases the risk of injury for your wrists and arms.

2

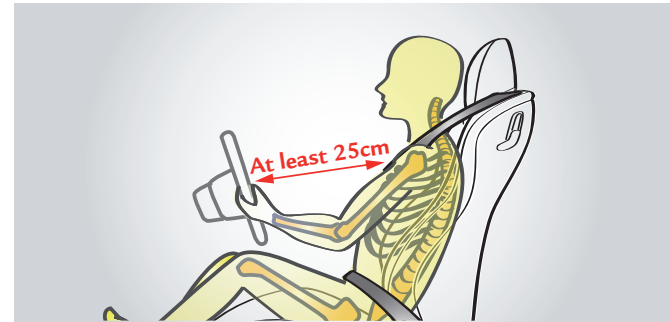



Warning



The front passenger must be seated correctly and must avoid putting hands, feet or legs on the dashboard since if the front airbag is activated, it may cause injury to legs and prevent the airbag from working properly.

Operating

The front airbags are controlled by an ECU which activates them when there is a sufficiently severe head-on collision (direction of impact between 11 and 1 o'clock p.m.).

In the event of a collision with an impact force that causes deceleration that exceeds the value set for the internal sensor, the ECU will transmit a signal to deploy the airbags. The airbags will begin to inflate, breaking the cover along the breakage line and will deploy completely in a few tenths of milliseconds. Once deployed, they will serve as protection between the driver and/or passenger and structures that could cause injury.

The airbags deflate immediately afterwards.

Warning



The driver and passenger should not carry objects (drink cans or bottles, pipes, etc.) that may cause injury if the airbags are activated.

Persons, animals or items must not be placed between the airbags and the occupant.

Environment



When the system is activated, gases are released in the form of fumes, together with the gas used for inflating the airbags. These gases are not harmful.

The driver's airbag has been designed to be deployed according to the following strategy:

- For low severity crashes, the airbag control unit will not deploy the airbag.
- For crashes of higher severity, the control unit will deploy the driver airbag in low energy mode.
- For crashes of even higher severity, the control unit will deploy the driver airbag in high energy mode.

The passenger airbag has been designed to be deployed according to the following strategy:

- For low severity crashes, the airbag control unit will not deploy the airbag.
- For crashes of higher severity, the control unit will deploy the passenger airbag in low energy mode.
- For crashes of even higher severity, the control unit will deploy the passenger airbag in high energy mode.

Warning



The driver and passenger must always fasten their seat belts and sit in an upright position, as far as possible away from the airbag, in order to have optimal protection in all types of collision.



Warning



Always keep the backrest of your seat in the upright position and sit with your back properly resting against it.

Important note



Do not modify the system components or wiring, under any circumstances.

With the ignition key inserted and in position II, although the engine is off, the airbags can still be activated when the vehicle is stationary if it is hit by a moving vehicle.

Remember that if the ignition key is set to 0 none of the safety devices (airbags or pretensioners) is activated in the event of a collision; failure of the airbags to inflate in these circumstances is not indicative of a system malfunction.



Important note



Do not cut or tamper with the connectors of the airbag harness or on the airbag modules.

Warning



Do not cover the steering wheel and the padded panel on the dashboard on the passenger's side with adhesive tape or treat it in any way.

Warning



Do not place objects above or near the top of the dashboard and the steering wheel.

In the event that the airbags are deployed, these objects would be projected into the passenger compartment at a high speed that would seriously jeopardise the safety of the occupants.

2



Warning



Do not modify the airbag modules in any way (indicated in the relevant picture). Do not damage the airbag modules (for example pinning something onto them or pressing objects against their covers).

If, for any reason, an airbag cover gets damaged, have the airbag module immediately checked by the FERRARI SERVICE NETWORK.

Activation of a damaged module could cause serious or fatal injuries.

Important note



Do not remove or dismantle parts of the steering wheel, dashboard or door panels; if necessary, this procedure should only be performed by a FERRARI SERVICE NETWORK CENTRE.

Important note



All the airbag system components must be replaced after an accident that caused airbag deployment.

Important note



Following an accident not involving airbag deployment, contact the FERRARI SERVICE NETWORK to have the system checked and any system components that may be damaged or malfunctioning replaced.

Important note



The airbag system components have been specially designed only for this specific vehicle model. Do not use them on a different vehicle model, as this may cause serious damage and consequent injury, even fatal, to the occupants in the event of an accident.

Warning



Damaged or defective components of the airbag system cannot be repaired and must be replaced.

Improper operations performed on the system components may cause failures or accidental deployment or failure of the airbags to inflate with consequent damage and injury, even fatal.

Environment



To scrap the vehicle, please contact the FERRARI SERVICE NETWORK to have the airbag system deactivated.



Important note



If the vehicle has been stolen or there has been an attempted theft, have the airbag system checked by the **FERRARI SERVICE NETWORK**.

The label **F** indicates the presence of the airbag system.

Warning



The passenger seat is not suitable for installing universal ISOFIX child car seats.

You are therefore advised **NOT** to transport babies or young children in this vehicle.

2





Side airbags

Warning



Airbags are not a substitute for seat belts but they increase their efficiency. Correct use of seat belts, with the supplementary action of the side airbags, offers maximum protection in the event of a collision or vehicle roll-over.

Side airbag system components

Warning



The side airbags fitted on the vehicle have not been designed to reduce the risk of being thrown out in the event of vehicle roll-overs.

The vehicle has 2 side airbags, one in the driver-side door and the other in the passenger-side door.

The side airbag system consists of 2 airbags, one on each door. In the event of a side collision, the airbag on the impact side deploys immediately to protect the occupant's head.

Warning



When the ignition key is turned to position II, the warning light A will come on. If no malfunctioning in the airbag system is detected, it will go off after 4 seconds. If the warning light does not come on, if it remains on or if it comes on while driving, contact the FERRARI SERVICE NETWORK immediately.

Operating

The side airbags are controlled by the ECU that activates them when a sufficiently severe collision occurs.

In the event of a side collision with a force of impact exceeding the limit set by the ECU, this will transmit a signal that activates the pretensioner and the side airbag on the impact side.

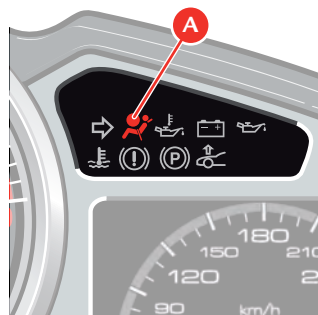



The airbag will start inflating, opening its cover along the breaking line, until it is fully deployed (in a few hundredths of seconds). After deployment, the side airbag will be positioned as a protection between the driver's or passenger's head and the external structures which could penetrate the passenger compartment and cause injury. The airbags deflate immediately afterwards.

Side airbag activation is not affected by the occupant's height or weight. The side bag is activated whenever the airbag ECU detects a collision of a sufficient impact force for deployment.

Warning



Never drive with your head out of the window as this places your head and neck in the airbag deployment area. In the event of a side-on collision, this position increases the risk of being thrown out of the vehicle and compromises the protective effect of the side airbags.

Warning



Never place an object over or near the airbag covers. In the event that the airbags are deployed, these objects would be projected into the passenger compartment at such high speed as to seriously jeopardise the safety of the occupants.

Warning



Never modify the airbag modules. Do not damage the airbag modules or the trim panels covering (upper area of door panel), by pinning objects onto them or pressing objects against their respective covers, for example.

If, for any reason, an airbag cover gets damaged, have the airbag module immediately checked by the FERRARI SERVICE NETWORK. Activation of a damaged module could cause serious injuries.

2

Important note



Please consider that the airbag ECU is not capable of automatically detecting damages involving the airbag covers.

Do not cover the upper part of the driver-door and passenger-door panels with adhesive tape or material and do not treat them in any way.

Warning



After deployment, the airbag components can no longer offer any protection; therefore, they cannot be repaired and must be replaced. After activation of a side airbag, have it replaced by the FERRARI SERVICE NETWORK.



Warning



The airbag modules are subject to wear and tear and must be replaced at the intervals indicated in the “Warranty Booklet” EVEN if the vehicle has NOT been involved in a collision.

Important note



Never remove the door panel. If required, this operation must be performed by the FERRARI SERVICE NETWORK.



Fuel inertia switch

The fuel inertia switch is a safety device which deactivates the fuel pump relays if a collision occurs.

A symbol appears on the left TFT display and the hazard warning lights come on to indicate that the switch has been activated.

When the fuel inertia switch is activated, the doors are also unlocked (if locked) and the central dome light comes on.

2

Warning



The fuel pump relays can be reactivated by pressing the button in the battery compartment which can be accessed by opening the passenger side footrest.





ABS and EBD

The **ABS** system is a safety device which activates to prevent wheel locking if the driver presses the brake pedal too sharply, especially under low grip conditions.

The system is composed of:

- electro-hydraulic unit
- electronic brake-force distribution **EBD**
- four speed sensors on the wheels, incorporated in the bearings.
- the entire ESP sensor system (steering angle sensor, accelerometer, yaw sensor, etc.).

These features add to the vehicle's standard braking system, without changing its characteristics.

Important note



When the **ABS** system is active, during emergency braking or in poor grip conditions, a “pulsing” sensation will be felt through the brake pedal. Hold the brake pedal down to continue the braking action.

When one of the wheels starts locking, the hydraulic control unit controls the braking circuit by running a 3-phase cycle:

- reduction (if necessary)
- maintenance
- pressure increase in the hydraulic circuit.

In the event of **ABS** activation under braking, these regulation cycles will be repeated until the car comes to a stop or pressure on the brake pedal is reduced.

In addition, the system offers the following advantages:

- Driving stability (no skidding): even in the event of sharp braking approaching wheel locking.
- Manoeuvrability (no side-skidding on sharp turns).

This means that even when an emergency situation requires sudden braking, the driver can avoid obstacles, or brake on a curve, without affecting the vehicle stability.

Warning



ABS system performance remains unaltered as long as the speed limit for the tyre side grip is not exceeded. If this limit is exceeded, vehicle skidding cannot be avoided.

- Optimal braking distance:
depending on the type of road surface, the braking distance may be reduced by as much as 40%.

Warning



The **ABS** system does **NOT** exempt the driver from driving carefully and responsibly at all times.



Important note



The **ABS** system improves braking distances in all conditions, but cannot compensate for the driver's failure to maintain safety distances or loss of control in poor road conditions.

The purpose of the **ABS** system is to maximise the efficacy of the brake system in all situations, and, in particular, at the limit of grip of the tyres and in changing road surface conditions.

FBP - Ferrari Brake Prefill

Brake design parameters provide a set distance between the brake pads and discs (the “air gap”): as soon as the brake pedal is pressed, the presence of the air gap leads to a slight delay in brake response.

The FBP (Ferrari Brake Prefill) system eliminates the air gap by applying slight pressure to the braking system as soon as the accelerator pedal is released just before braking. This results in more immediate brake response and reduces braking distance during emergency braking thereby improving safety.

ESC - Electronic Stability Control

The **ESC** system consists of two main systems:

VDC Vehicle Dynamics Control, performed through the braking system

F1-Trac traction control, performed through engine torque modulation, depending on maximum grip on the road and secondary systems that are always active such as the **ABS** and **EBD**.

To provide optimal control in different driving and grip conditions, four different settings have been developed:

- **Level 1:** (Manettino set to **WET**) ensures stability and maximises traction on every type of road surface, both in low and very low grip conditions, by means of engine and brake control (in this condition, the standard **ASR** system is activated instead of the **F1-Trac** function).
- **Level 2:** (Manettino set to **SPORT**) ensures stability and maximises traction only in medium- to high-grip conditions by optimising engine and brake control.
- **Level 3:** (Manettino set to **RACE**) enhances the racing features of the vehicle by reducing engine control to a minimum and maximising brake control. This mode is designed to ensure stability on the race track in high grip conditions only.
- **Level 4:** (Manettino set to **CT OFF**) further enhances the racing style performance of the vehicle: **F1-Trac** traction control is deactivated whereas stability control remains active when a certain level of sideslip is exceeded. **F1-Trac** traction control is off. Stability is **NOT** guaranteed.
- **Level 5:** (Manettino set to **ESC OFF**) **ESC** off. Stability is **NOT** guaranteed, but all other auxiliary systems such as **ABS**, **EBD** and the **E-Diff 3** electronic differential **remain active**. The **VDC** system remains active under braking.





F1-Trac

F1-Trac is a traction control system that derives directly from FERRARI's expertise in F1 vehicles.

F1-Trac is faster and more accurate than traditional control systems and is capable of delaying and minimising engine torque adjustments as required in order to ensure the desired trajectory.

The system estimates the maximum available grip in advance, by continuously monitoring the relative wheel speed and using an auto-adaptive operating logic. Comparing this information with the vehicle dynamics model stored in the control system, **F1-Trac** optimises the vehicle behaviour by controlling engine torque delivery.

Important note



F1-Trac does not work when the Manettino is set to CT OFF and ESC OFF driving modes.

The main feature that distinguishes the F1-Trac system from a traditional traction control system lies in its ability to estimate grip level accurately which allows the driver to make full use of the vehicle's performance driving potential.

The **F1-Trac** system guarantees:

- maximum traction when coming out of bends;
- driving stability and ease even under extreme driving conditions;
- driving comfort.

On this vehicle, integration of the **F1-Trac** and E-Diff 3 systems ensures maximum performance and stability.

E-Diff 3

The vehicle is equipped with an electronic differential, working on the rear axle, which continually performs a variable check on the locking between the two axle shafts.

The electronic differential system, integrated with **F1-Trac** traction control, is capable of improving:

- performance;
- directional stability of the vehicle;
- active safety even when close to grip limit;
- driving comfort and handling.

The system is based on the analysis and forecast of vehicle performance in all possible conditions. This is done by continually monitoring the pressure of the clutch actuator on the differential.

The input signals are the dynamic parameters of the vehicle that the control system translates into a torque difference between the two driving wheels.

On bends, the electronic differential can:

- stabilise the vehicle when the accelerator pedal is released by locking the rear axle;
- control vehicle dynamics by locking the differential according to lateral acceleration and vehicle speed;
- maximise vehicle stability and, at the same time, acceleration on bends by locking the differential according to lateral acceleration, speed, engaged gear and torque produced by the engine.

To obtain these results, the electronic differential system interacts with the **F1-Trac**, **ESC** and **ABS** systems, F1 gearbox and suspension damping control.



EPB - Electric parking brake

On this vehicle the parking brake is actuated by an electric motor. The parking brake can be applied and released by pulling a special lever **B** on the dashboard to the left of the steering wheel. With the ignition key turned to **II**, the relative indicator on the instrument panel (see page 108) lights up to indicate when the parking brake is engaged.

Pull the lever **B** while holding the brake pedal depressed to release the parking brake. If the ignition switch is turned to **II**, the indicator extinguishes once the parking brake is completely released.

The electric parking brake may be used as an emergency brake when the vehicle is in motion. If this is the case, the system acts on all four wheels until button **B** is released by communicating with the ESP system which prevents locking.

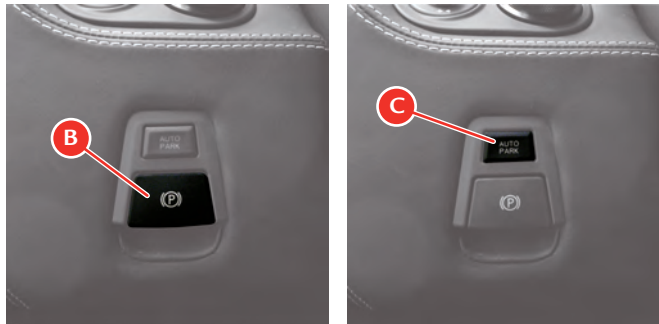

Warning



Always apply the parking brake when the vehicle is parked.
The vehicle should be blocked. If this is not the case, please contact the **FERRARI SERVICE NETWORK**.

2

Autopark Function

The EPB Autopark function automatically activates the electric parking brake when the engine is switched off. At each Key-on, the Autopark function is always active by default: this means that the driver does not need to apply the parking brake when the engine is switched off.

However, the function can be temporarily deactivated before switching off the engine by pressing the **AUTO PARK C** button: the message “PARK OFF” is displayed on the left TFT display for 5 seconds. In this case, after the engine is switched off, the parking brake must be engaged manually by pulling the lever **B**. To re-enable automatic EPB engagement at the next key-off, press the button **C** again; the message “PARK ON” is displayed on the left TFT display for 5 seconds.

“Automatic Vehicle Holding” AVH function

The Automatic Vehicle Holding function of the electric parking brake ensures optimised release when moving off from a standstill: after engine start, the system uses the service brakes to hold the vehicle instead of the parking brake shoes.



Tyre temperature and pressure monitoring system TPMS

The vehicle can be equipped on request with a system that measures the tyre pressure and temperature using special sensors fitted inside the wheel rims next to the air valve. These sensors transmit a signal that is received by the antennas on the car body, behind the gravel guards, that are connected to the ECU.

Important note



The system may be momentarily affected by radioelectrical interference from devices that use similar wavelengths.

The ECU processes this information and transmits data on tyre pressure and temperature and any system errors to the instrument panel.

The signal transmitted by the ECU activates symbols on the left TFT display (see page 84) with two priority levels: a **soft warning** (SW) if the pressure loss is **0.2 bar more** than the rated pressure and a **hard warning** (HW) if it is **0.5 bar more** or there is a dynamic decrease of over 0.2 bar/min.

The TPMS can be calibrated using the special menu item in the left TFT display (see page 86).

Important note



System calibration using the special menu item on the left TFT display is necessary after replacement or inflation of a tyre or tyres.

Warning



The TPMS warns the driver that the tyre pressure has decreased. However, this does **NOT** exempt the driver from periodically checking that the tyres are inflated to the indicated pressure.

In addition, the system does **NOT** warn the driver of damage to the tyres by external agents.

Displaying messages on the left TFT display

By using the commands on the left TFT display (see page 84), the driver can access the TYRES screen page which displays the vehicle symbol with the pressure and temperature values of each tyre as shown in example 1.

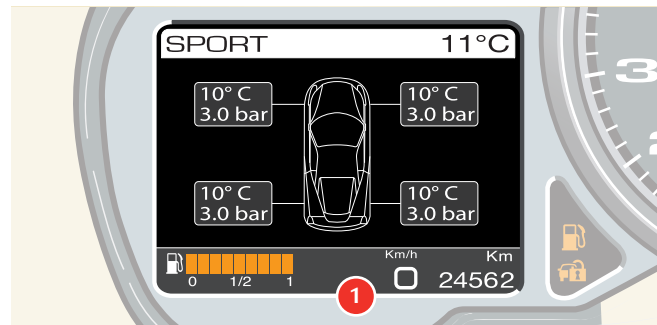



If the TYRES screen page is being displayed and an event occurs that needs to be shown as a symbol and/or special message, the screen page is minimised as shown in example 2. For further information, refer to the paragraph “Fault visualisation logic” on page 101.

Low pressure

Regardless of the type of screen page on the left TFT display, when the instrument panel receives the signal from the tyre pressure ECU that the pressure level of one or more tyres is below the alarm threshold, the screen page shown in example 3 (for a warning related to only one tyre) or example 4 (for a warning related to several tyres) appears immediately.

The screen page is displayed for 20 seconds and then the screen page that was previously displayed reappears. If the failure persists, the screen page shown above (example 3 or 4) will be automatically displayed for 20 seconds the next time the engine is started.

The driver can call up the TYRES screen page at any time to display which tyres have low pressure (example 5).

2

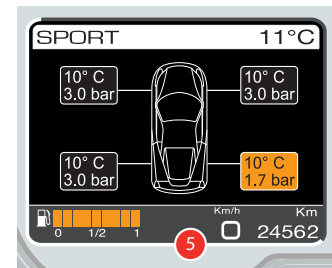
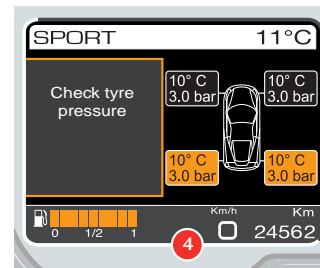
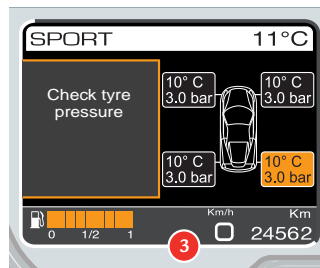
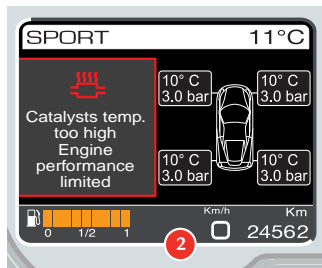



Occasionally, the system may not detect which wheel signals a failure. If this is the case, then only the message “Check tyre pressure” will be displayed as shown in example 6.

Tyre puncture

Regardless of the current active page on the left TFT display, when the instrument panel receives the signal from the tyre pressure ECU that the pressure level of one or more tyres is below the alarm threshold, the specific screen shown in example 7 (warning to stop driving the vehicle, if vehicle is equipped with normal tyres) is displayed immediately.

At the same time, a warning light comes on on the panel (see page 107) in fixed mode.

The screen page is displayed for 20 seconds and then the screen page that was previously displayed reappears whereas the warning light remains on in fixed mode.

If the vehicle is fitted with normal tyres, the fault is displayed with the same display logic applicable for other priority 0 faults (see the paragraph “Fault visualisation logic” on page 101) until the correct operating conditions are restored and the system is subsequently recalibrated.

If you call up the TYRES screen page, you can identify the punctured tyre at any time (example 9).

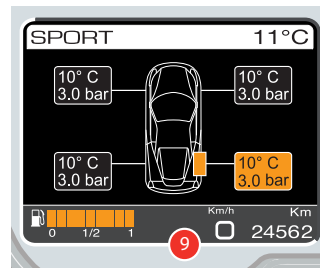
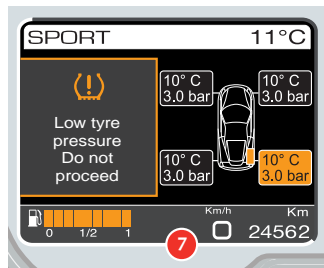
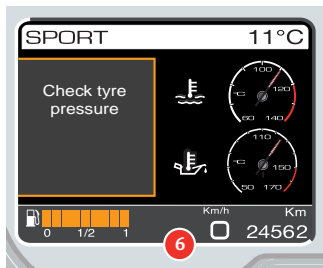



If another tyre is punctured, the instrument panel will update the number of km (mi) which can still be driven according to the distance driven after the previous puncture and will display the screen page shown in example 10.

While a priority level 0 (normal tyre puncture) or priority level 2 (Run Flat tyre puncture with maximum speed limit not exceeded and tyres still usable) fault is active on the display, the driver may press **OK** to “ESCAPE” (see page 101): the screen page disappears whereas the warning light on the panel remains on in fixed mode.

As above, the TYRES screen page can be called up at any time to display which tyres are punctured (example 11).

Occasionally, the system may not detect which wheel signals a failure. If this is the case, the screen page shown in example 12 (for vehicles fitted with normal tyres) or example 13 (for vehicles fitted with Run Flat tyres) will be displayed.

The symbol and message are displayed for 20 seconds and then the screen page that was previously displayed reappears whereas the warning light remains on in fixed mode.

If the vehicle is fitted with Run Flat tyres, the instrument panel will calculate the residual tyre life and will redisplay the screen page shown in example 13 after 50 km (31 mi). The same screen page (warning not to exceed a maximum speed of 80 km/h) is displayed if the vehicle exceeds 80 km/h (50 mph). Once the distance of 100 km (62 mi) has been exceeded, the panel displays the screen page shown in example 12 (warning not to proceed).

2

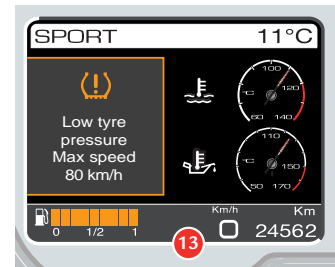
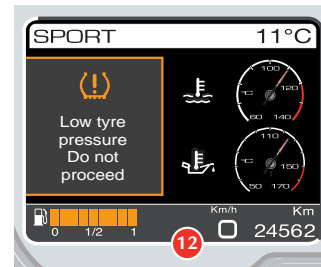
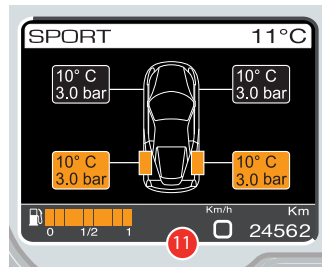
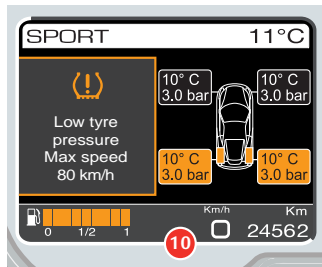



System not calibrated

If the system has not been calibrated or one or more tyres have been replaced, the symbol and message shown in example 14 will be displayed. Simultaneously, the specific warning light on the instrument panel (see page 107) starts flashing, and continues to flash for 90 seconds.

When the display cycle ends (20 seconds), the symbol and message disappear and the screen page that was previously displayed reappears whereas the warning light remains on until the system has been calibrated.

The TPMS can be calibrated using the special menu item in the left TFT display with the ignition key in position II and the engine off.

To calibrate the TPMS, call up the MENU screen page on the left TFT display (see page 86) with the ignition key in position II and the engine off. Once the MENU screen page appears, select the items “Car setup”, “Calibr. TPMS”.

When the Menu item is displayed and the subsequent calibration accepted, the screen page shown in example 15 appears for 5 seconds.

Warning



Before calibrating the system, make sure that the tyre pressure corresponds to the indicated pressure values (see page 29). If this is not the case, the TPMS may issue wrong low pressure indications.

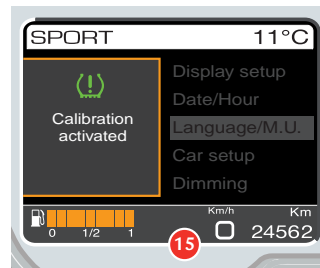
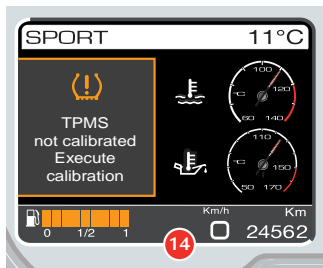



TPMS failure

The screen page shown in example 16 is displayed in the following circumstances:

- malfunction in the circuit and/or wiring connecting the ECU
- signal is not received by one or more sensors due to a faulty, broken or flat battery
- fault in the TPMS ECU.

Simultaneously, the specific warning light on the instrument panel (see page 107) starts flashing, and continues to flash for 90 seconds. The warning light then remains on in fixed mode until the situation is corrected.

The TYRES screen page cannot be called up by the driver.

System temporarily not active

The screen page shown in example 17 is displayed in the following circumstances:

- overheating of sensors
- during calibration (the TPMS ECU does not recognise the sensors)
- radio frequency that interferes with the wheel sensor signal.

Simultaneously, the specific warning light on the instrument panel (see page 107) starts flashing, and continues to flash for 90 seconds. The warning light then remains on in fixed mode until the situation is corrected.

The TYRES screen page cannot be called up by the driver.

System not active

For a few seconds at key-on, if the TPMS has been deactivated by a diagnostic tool, the screen page in example 18 is displayed.

Simultaneously, the specific warning light on the instrument panel (see page 107) starts flashing, and continues to flash for 90 seconds. The warning light then remains on in fixed mode until the situation is corrected.

The TYRES screen page cannot be called up by the driver.

2

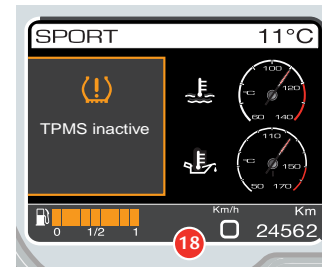
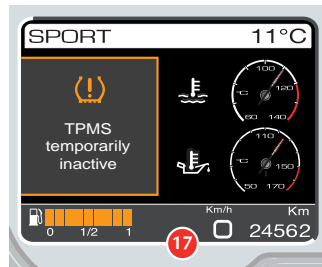
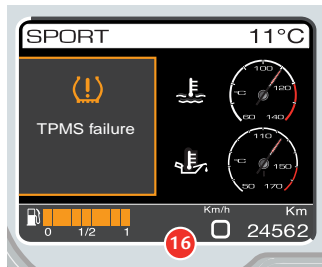

Doors	72
Engine compartment lid.....	74
Luggage compartment lid	75
Ignition switch.....	77
Fuel filler flap and neck	78
Power windows	80
Instruments and gauges	82
Cruise Control (optional).....	114
Controls on the steering wheel	116
Active aerodynamics (DRS)	117
Slip Side angle Control (SSC)	119
Lighting.....	124
Driving the vehicle	130
EPB - Electric parking brake	148
Park Lock	150
Launch Control	151
Stop&Start system (optional).....	152
Seat adjustment	162
Air conditioning and heating system	166
Passenger compartment accessories	170





3



ABOUT YOUR VEHICLE





Controls overview



Ref.	Control	Page	Ref.	Control	Page
1	Adjustable air vents	169	4	Light switch	124
2	Knee guard	170	5	External rear-view mirror adjustment control	164
3	Climate control system control panel	166	6	Left TFT display controls	84



Ref.	Control	Page
7	Left TFT display	84
8	Rev counter and gearbox display	109-110
9	Right TFT display	112
10	Turn indicators	126
11	Windscreen washer/wiper lever	121
12	“Manettino” control	116-140
13	“ENGINE START” button	116
14	Suspension damping delink button	120-144
15	High beam and flashing lever	124

Ref.	Control	Page
16	Front Lift system control (optional)	160
17	Power window controls	80
18	“LAUNCH” control	151
19	“R” reverse control	133
20	Air conditioning controls	166
21	“AUTO” control	136
22	Hazard warning lights control	127

3

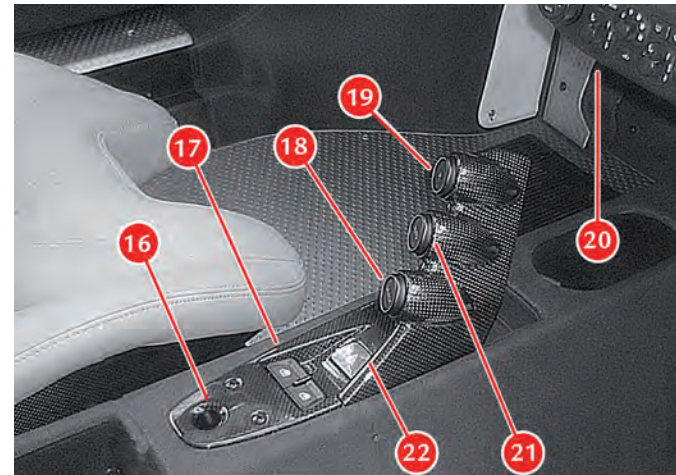



Doors

When a door is opened or closed, the window automatically moves down by approximately 2 centimetres / 0.8 inches (to its “target position”) to avoid colliding with the upper weather strip.

When the door is closed, the window automatically moves up until it reaches the “upper limit”.

Opening from the outside

Using the remote control, deactivate the alarm and the central door locking system, or turn the key in the lock to deactivate the central door locking system.

To open the door, pull handle **A**: the window will move down to its “target position”. When the door is closed, the window will move up until it meets the upper limit.



Locking and opening the doors from the inside

Warning



Always carefully check manually that the doors have been closed properly to prevent them from opening while driving.

Both doors can be locked by activating/deactivating the “LOCK/UNLOCK” **B** button on the roof panel. To lock the doors, press button **B**; when the door lock is activated, the light on button **B** comes on. To deactivate the door lock, press button **B** until the light goes out.

The rolling lock function, which automatically locks the doors when the vehicle speed reaches or exceeds 20 Km/h, may be activated from the “Car setup” menu accessible from the left hand TFT display of the instrument panel (see page 86).





If you pull handle **C** to open the door, the window will move down to its target position. When the door is closed, it will move up until it meets its upper limit.

If handle **C** is lifted without opening the door, the window will move down to its target position and stop and if the door is not opened after 2 seconds, the window will move back up until it meets the upper limit. Therefore, to open the door, release handle **C** and pull it again.

When the opening handle is operated, both doors are unlocked.

3



Engine compartment lid

Opening

Pull the release lever **D** on the driver side inner pillar.

Lift the engine compartment lid. The lid is held open by two gas struts **E**.

The engine compartment lid can also be opened with the ignition key at off.

Closing

Lower the lid until it is closed and press down near the lock until you hear it click in place.

Warning



Always check manually that the engine compartment lid has been closed properly to prevent it from opening while driving.

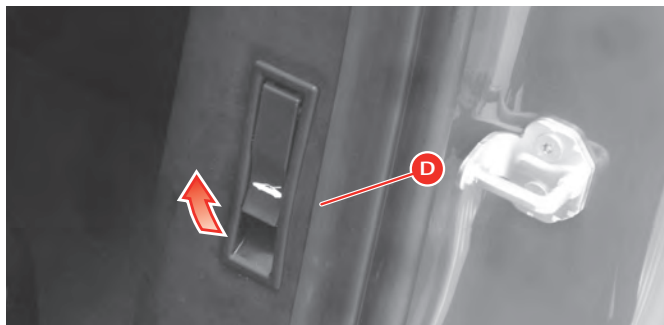



Luggage compartment lid

Opening

The luggage compartment lid can also be opened with the ignition key at off.

Push the release button **F** on the inner side of the driver door or press and hold button **G** on the ignition key for more than 2 seconds.

Stand in front of the vehicle, slightly lift the lid and pull the retaining lever **H** to lift it completely.

The lid is held open by two gas struts **L**.

The luggage compartment is illuminated by two light units which activate automatically when the luggage compartment lid is opened.

Important note



After removing the battery from the vehicle or disconnecting it from the electrical system, a door lock/unlock cycle must be performed using the buttons on the key when reconnecting so that the release button **F** resumes normal operation (electronic system self-acquisition procedure).

3

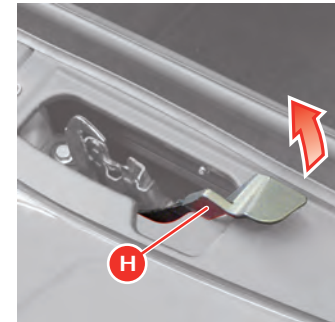
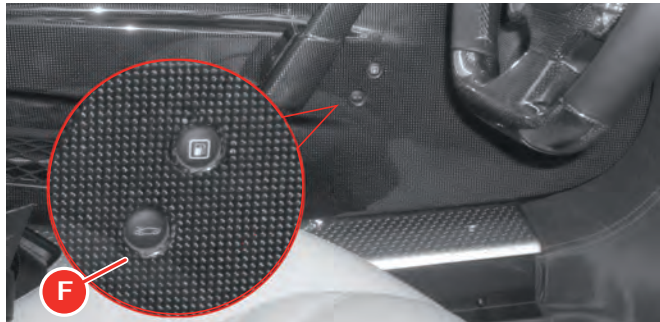



Closing

Lower the lid until it is closed and press down near the lock until you hear it click in place.

Warning



Always check that the luggage compartment lid has been closed properly to prevent it from opening while driving.

Emergency Opening

If the luggage compartment lid opening button does not work, there is a string for manual emergency opening underneath the dashboard to the left of the steering wheel as shown by the arrow in the figure.





Ignition switch

The ignition key can be turned to 2 positions:

Position 0 - Stop

Engine off, key removable.

When the key is even only partially extracted, the steering column is locked.

The hazard warning lights and parking lights can be activated.

To facilitate steering wheel release, turn the steering wheel slightly clockwise or counterclockwise while turning the ignition key.

Position II - Start

When the key is turned to this position (key-on) the signals generated by the vehicle systems are checked.

The left and right TFT displays are activated on the instrument panel and when the signals have been checked, the gearbox display comes on (see page 110).

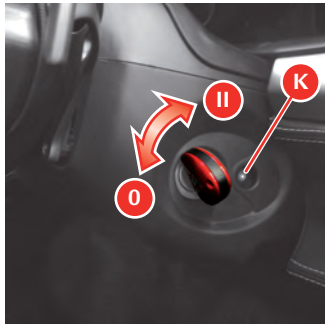

Warning



Never remove the key when the vehicle is moving!

The steering wheel will lock with the first turn of the steering wheel.

Always remember to remove the key from the ignition when you get out of the vehicle!

Never leave people who are more subject to injury unattended in the vehicle.

3

Key lock

If more than 20 seconds elapse after turning the key to position 0, the key lock device must be released to remove the key:

press button **K** and remove the key at the same time.



Fuel filler flap and neck

Warning



Always turn off the engine during refuelling.

Do not smoke or use naked flames when refuelling. There is a risk of fire.

The following can be harmful for your health:

- fuel coming into contact with your skin
- inhaling fuel vapours.

Opening

To open the fuel filler flap, press button **M** on the inner side of the driver door.

Closing

To close the fuel filler flap, push it until it clicks in place.

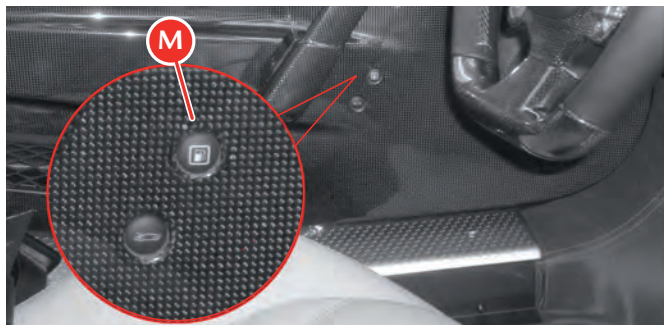

Emergency Opening

If the opening button does not work, the fuel filler flap can be opened manually by pulling the cable **P** on the right-hand side of the engine compartment.

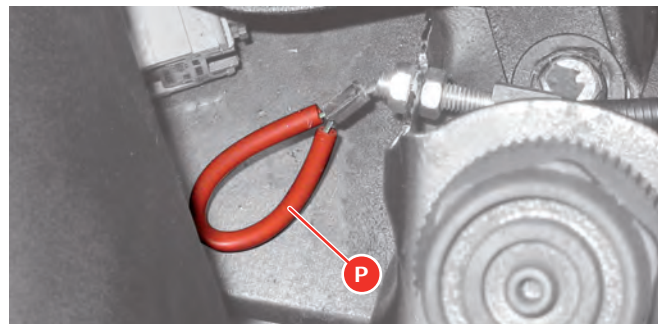



Capless filler neck

This vehicle has a capless filler neck for fuelling. This system allows you to refuel by opening the fuel filler flap and simply placing the nozzle in the filler neck without having to unscrew a cap and screw it up again.

Two flaps placed in series, both with airtight seals, act as a cap. The external flap is locked by a series of “teeth” and the only way to open the external flap correctly is by inserting a petrol pump nozzle.



Warning



Place the nozzle in the filler neck carefully to avoid damaging the device seal.

Do not try to open the external flap of the filler neck by pushing it with your fingers or lever it open using unsuitable tools (e.g. screwdrivers). This may damage the external flap mechanism, compromising the seal integrity and safety of the system.

Warning



Do not overfill the fuel tank: this may cause the fuel to leak out. After fuelling, wait for about 5 seconds before slowly removing the nozzle from the filler neck: in this way, the last drops of fuel will flow into the tank and will not drip onto the vehicle.

Warning



Do not place funnels or portable container nozzles in the filler neck.

If you need to refuel from a portable fuel container, use only the funnel supplied in the tool bag (see page 172) that releases the automatic closing device.

3



Power windows

The power windows can only be used with the ignition key in position II.

Driver-side power window

Press button **A** to move the window up or down.

This allows manual operation (partial opening/closing) or automatic operation (complete opening/closing): press button **A** and quickly release to activate manual operation; if the button is pressed at length (over 0.3 seconds), automatic window operation is activated. The window will only stop when it reaches the end of its travel or by pressing the button again.

Passenger-side power window

Press button **B** to move the window up or down.

Only manual operation is possible (partial opening) to raise the window: when button **B** is released, the window stops at the position reached.

To lower the window, automatic operation is also possible (full opening): if the button is pressed at length (over 0.3 seconds) automatic window operation is activated. The window will only stop when it reaches the end of its travel or by pressing the button again.

When the door is open, the window moves down to its “target position”; this is to prevent the window from colliding with the upper weather strip when it is closed.





Warning



Improper use of the power windows may be dangerous. Before use, always check that people and objects are at a safe distance.

Pay particular attention during the automatic operation of the driver-side power window.

To protect the passengers remaining in the car against accidental activation of the power windows, always remove the key from the ignition.

3



Instruments and gauges





3

- 1 Left hand TFT display
- 2 Rev counter
- 3 Right TFT display
- 4 Gear display
- 5 Warning lights on the panel
- 6 Manettino status
- 7 Fuel level



Left TFT display

Located on the instrument panel, it performs the following functions:

- displays the control parameters
- displays general information while driving
- displays fault warnings.

The driver can interact with the system by selecting the configuration and setting the parameters using the controls on the dashboard to the left of the steering wheel.

The display is activated and set by pressing the MAIN (A), VDA (B), OK (C) and UP, DOWN, LEFT, RIGHT (D) buttons.

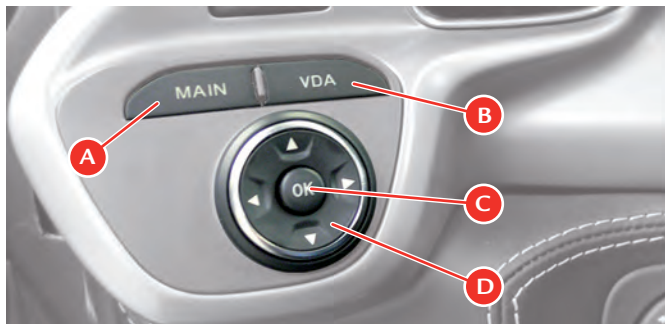

MAIN screen page

If you press the MAIN button, you activate the MAIN screen page which can be used to access the four screen page groups SETUP, VDA, TRIP and STATUS. These groups contain the following screen pages:

SETUP (pressing the UP button)

MENU screen page

STATUS (pressing the DOWN button)

SPORT screen page

SPORT 2 screen page

TYRES screen page (only if TPMS is present)

VDA (pressing the LEFT button)

Chronometer screen

(not available if vehicle is equipped with Ferrari Telemetry)

Vehicle Status screen

Manettino Status screen.





TRIP (pressing the RIGHT button)

TRIP A screen page

TRIP B screen page (only if previously enabled).

Press the RIGHT and LEFT buttons to sequentially switch between screen pages in a group. Press RIGHT to go to the next screen page (for example, in the STATUS group from SPORT to SPORT 2) and press LEFT to go to the previous screen page. Press the RIGHT button after the last screen page to go back to the first screen page and press the LEFT button after the first screen page to go back to the last screen page.

When a screen page is called up, it remains on the display until you decide to select another one.

Every screen page consists of four display areas:

- A** - selected driving mode (Manettino position), DRS status, windscreen wiper status, external temperature and “ice hazard” icon.
- B** - display of virtual control gauges, parking sensor screen page, display of abnormal events/warnings (message text and special symbol, when available), display of brightness adjustment function.
- C** - total or trip odometer (TRIP A or B), range.
- D** - fuel level gauge, area for minimised symbol for faults that do not have a specific warning light on the panel (see page 101), speed repetition.

3

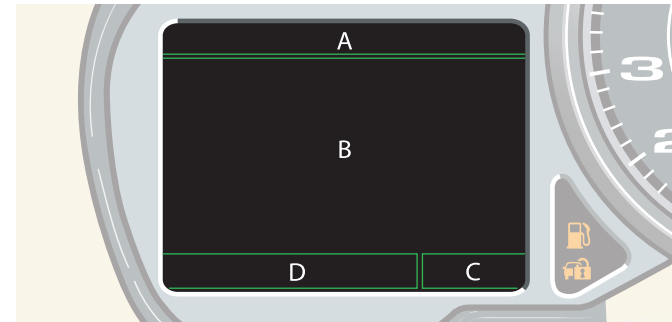



Display setting and configuration of vehicle parameters

Warning



The display settings and parameters must only be adjusted while the vehicle is stationary

MENU screen page

Display setting and configuration of the various vehicle parameters is possible using the MENU screen page (the only screen page in the SETUP group) that can be directly called up by pressing the UP button when the MAIN screen page is activated.

Navigation within the menu is on several levels; the first level offers a list of items through which the following parameters can be set or the following information can be displayed:

- **Dimming:** display dimming setting
- **Display setup:** display setting
- **Date/Hour:** date and time setting
- **Language/M.U.:** language and units of measurement setting
- **Car setup:** vehicle parameter configuration
- **Calibr. TPMS:** TPMS calibration (only if present)
- **Service:** information on scheduled maintenance.

These items are the main menu functions. To scroll through the list of items, press the UP and DOWN buttons; to select the required function, press and quickly release the OK button or the RIGHT button.

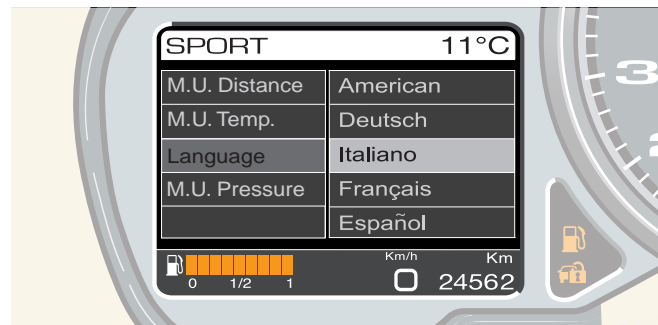
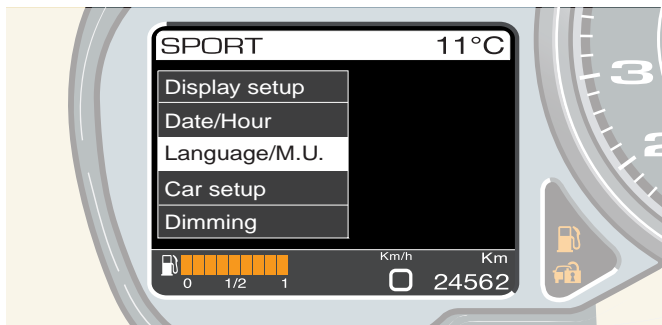



Once the function has been selected, the individual subfunctions or parameters that can be activated are displayed. To select them, use the UP and DOWN buttons and press and quickly release the OK (or RIGHT) button to activate a subsection or activate the selected parameter.

To go back to a previous level in the menu hold down the OK button, press the LEFT button or select the BACK item which is normally in the list of subfunctions. If no operation is performed for at least 10 seconds, the previous menu level reappears on the display.

Adjusting brightness

The brightness setting of the two TFT displays on the instrument panel is adjusted from the specific option in the MENU screen.

3





Fuel level gauge

The fuel level gauge is always displayed in area **D** of the display (see page 85). The gauge has 9 yellow bars that gradually “turn off” as the fuel level drops.

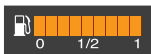

When the second bar goes off, the first bar turns red until fuel runs out.



When the reserve fuel is reached, in addition to the activation of the relative warning lamp on the instrument panel (see page 104), the relative symbol and specific message, together with the remaining range in Km, are shown on the display for 10 seconds. If the condition that has generated it persists, this signal is repeated every 8 km (5 mi).

In limited cruising range conditions, the information on driving range in km is replaced by the words “Limited cruising range”.

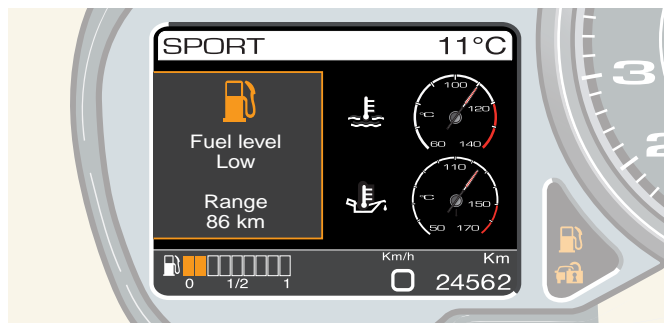



SPORT screen page

The SPORT screen page displays the following virtual gauges:

- Engine coolant temperature
- Engine oil temperature.

If the SPORT screen page is being displayed and an event occurs that needs to be displayed as a symbol and/or special message, the virtual gauges are minimised. For further information, refer to the “Fault displaying logic” paragraph on page 101.

SPORT 2 screen page

The SPORT 2 screen page displays the following virtual gauges:

- Engine oil pressure
- Voltmeter.

If the SPORT 2 screen page is being displayed and an event occurs that needs to be displayed as a symbol and/or special message, the virtual gauges are minimised. For further information, refer to the “Fault displaying logic” paragraph on page 101.

3

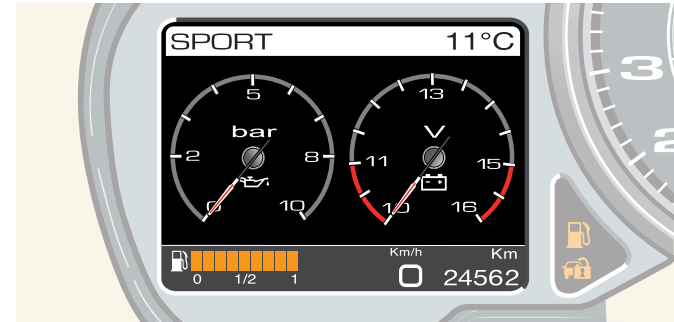
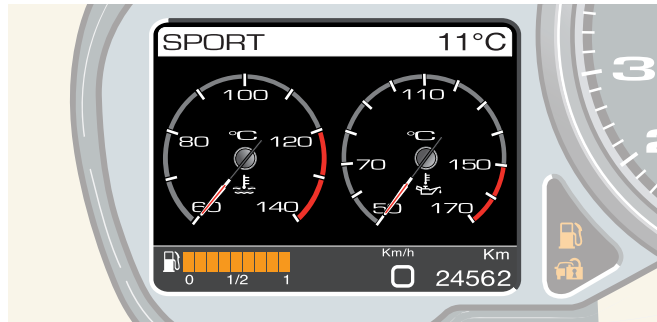



TYRES screen page (only if TPMS is present)

The TYRES screen page, available only if there is a TPMS (tyre pressure and temperature monitoring system), displays the vehicle symbol and indicates the pressure and temperature values for each tyre.

If the TYRES screen page is being displayed and an event occurs that needs to be displayed as a symbol and/or special message, the screen page is minimised. For further information, refer to the “Fault displaying logic” paragraph on page 101.

VDA (Vehicle Dynamic Assistance) screen page group

In addition to its chronometer function, the Vehicle Dynamic Assistance (VDA) screen page group provides a valid support for assessing vehicle status when on the track and can be used to intuitively understand the most suitable conditions for performance driving. The VDA group, which is recalled by pressing the LEFT button with the MAIN screen page displayed or directly by pressing the VDA button with any screen page displayed, consists of the “Chronometer”, “Vehicle status” and “Manettino status” screen pages.

The “Vehicle status” screen page functions are only available when the “Manettino” driving mode control switch (see page 116) is set to RACE, CT OFF or ESC OFF, positions developed especially when using the vehicle on track; however, if the Manettino is set to WET or SPORT mode, the “Vehicle status” screen page is displayed along with the message “VDA not available in WET - SPORT”.

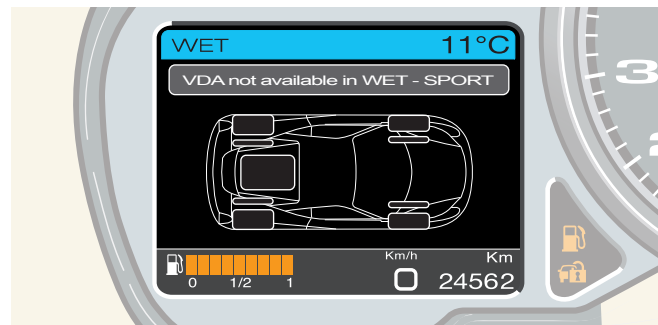
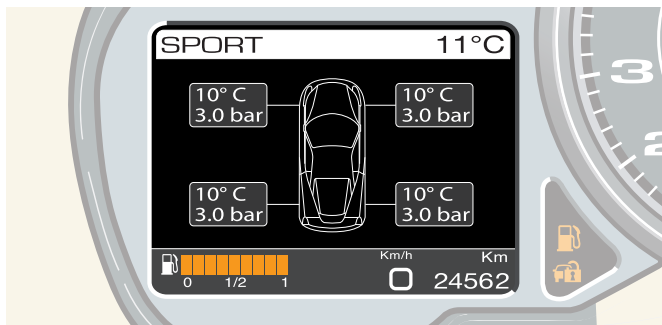



Chronometer screen page

The “Chronometer” screen page is used to time laps and memorise lap time in the event of occasional usage on the on track. The screen page displays the following information:

Current Lap

indicates the time elapsed since the start of the chronometer

LAP TIME / Best

indicates the time required to complete the last best lap

LAP TIME / Last

indicates the time required to complete the last lap

TOP SPEED / Best

indicates the maximum speed reached

TOP SPEED / Last

indicates the maximum speed reached in the last lap

If the “Chronometer” screen page is being displayed and an event occurs that needs to be displayed as a symbol and/or special message, the screen page is minimised. For further information, refer to the “Fault displaying logic” paragraph on page 101.

During display of the event/malfunction, the chronometer remains

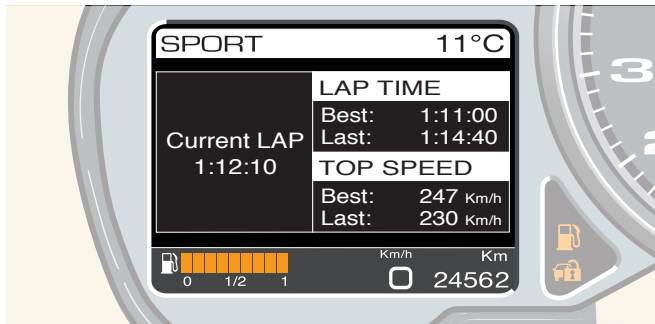

active.

The chronometer always resets each time the ignition switch turned on, while the last valid Best Lap, Best Speed, Last Speed and Last Lap information is memorised.

Chronometer operating logic

The chronometer is controlled using the OK, UP and DOWN buttons that perform the following functions:

- Pressing and quickly releasing the OK button:
 - when the chronometer is off, starts the Current Lap chronometer
 - when the chronometer is on, resets and restarts the Current Lap and updates the information on previous laps (end of lap/start of next lap).
- Pressing and quickly releasing the UP or DOWN button:
 - when the chronometer is on, stops the chronometer and updates information on previous laps.
- Holding down the UP or DOWN button:
 - when the chronometer is on or off, resets the chronometer and information on previous laps.

Note that during display of an event/malfunction, pressing and quickly releasing the OK button interrupts the event/malfunction display cycle (“ESCAPE” function), without affecting the chronometer.





Vehicle status screen page

The “Vehicle status” screen page, which is directly called up by pressing the VDA button or by pressing the LEFT button when the MAIN screen page is displayed, is intended to help the user bring the vehicle to optimum performance when driving on high grip surfaces.

This is made possible by an algorithm that determines the thermal state of the main vehicle subsystems (tyres, brakes and engine) in relation to the dynamics of various parameters (lateral acceleration, speed, etc.). The status of the vehicle is displayed concisely using three levels which are blue, green and red:

WARMUP

Warm-up stage for components and self-acquisition of control systems; during this stage, the vehicle should be driven so that it is taken to optimum conditions of use.

GO

The vehicle has completed the warm-up stage: all its subsystems have reached optimum conditions of use for performance driving.

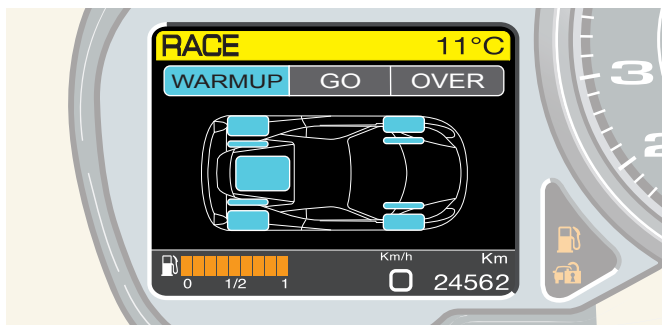

OVER

One or more systems have reached an overheating condition that may affect vehicle dynamics. Slowing down is therefore recommended to restore these systems to optimum conditions of use.

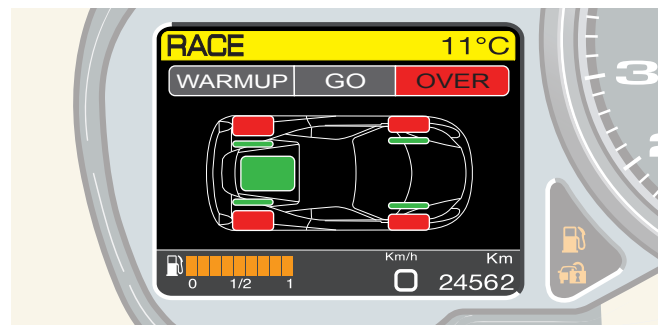
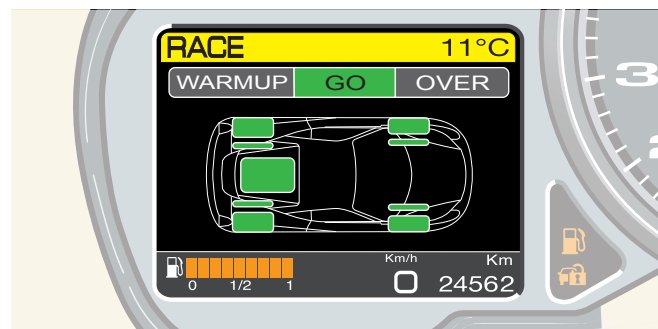



After each start, the ESC stability and traction control system compensates for the tyre rolling radius and detects the spare wheel. While this procedure is being performed, the Vehicle Status screen page indicates to the driver that system self-acquisition is in progress by displaying the message “ESC autolearning”.

Warning



Test-driving the vehicle on the race track: after each start, cover the first straight stretch of the track (at least 500 meters / 0.3 mi) at a constant speed so that the ESC stability and traction control system can calculate exactly the grip available and the rolling radius of the tyres (the calculation is reset every time the engine stops).

If this rule is not followed, system performance may be reduced.

If one or more signals related to the performance parameters used to calculate the thermal state of the subsystems (lateral acceleration, speed, etc.) are not valid, the Vehicle Status screen page indicates to the driver that the function is not available by displaying the message “Function not available”.

3

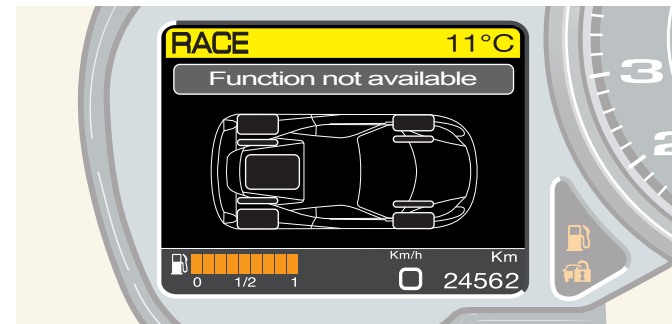
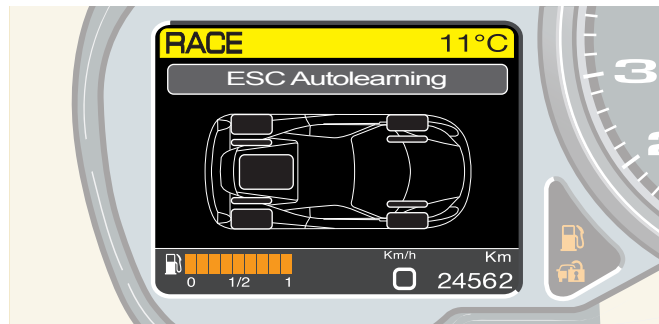



Manettino status screen page

The “Manettino status” screen page displays a list of parameters which can be configured using the “Manettino” driving mode control switch (see page 116) and indicates the configuration each one assumes in a specific driving mode.

The systems involved are the following:

- **F1-Trac**: traction control
- **E-Diff**: electronic differential
- **F1-DC**: dual clutch F1 gearbox
- **ESC**: stability and traction control
- **ABS**: anti-lock braking system
- **SCM**: magnetorheologically controlled suspension.

If one of the other two VDA screen pages is displayed (“Chronometer” or “Vehicle Status”), the “Manettino Status” screen page is displayed in timed mode for 3 seconds when the position of the Manettino is changed so that the driver is informed of the new status that the systems are in. After 3 seconds, the screen page that was previously displayed reappears.

The “Manettino status” screen page is also automatically displayed in timed mode at key-on if one of the other two VDA screen pages was displayed at the previous key-off and the Manettino was in a different position from the current one.

Important note



If there is a Manettino failure, the “Manettino Status” screen page cannot be displayed or recalled.

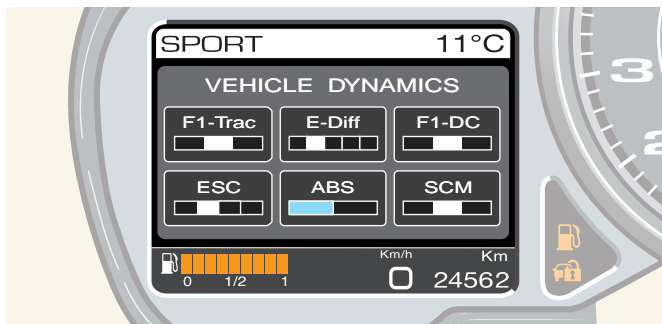



TRIP A and TRIP B screen pages

The TRIP A or TRIP B screen page displays the following information:

- **Maximum speed**
- **Average speed**
- **Travel distance**
- **Travel time**
- **Range**

If the TRIP A or TRIP B screen page is being displayed and an event occurs that needs to be displayed as a symbol and/or special message, the screen page is minimised. For further information, refer to the “Fault displaying logic” paragraph on page 101.

3

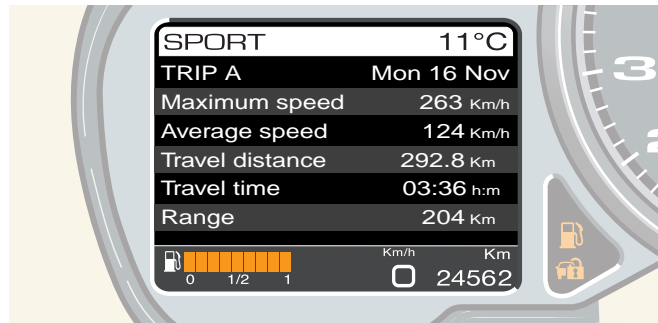



“Warning: danger of ice” message

To warn the driver of the presence of ice on the road if the outside temperature is 3 °C (38 °F) or below, the “snow” symbol and the “warning: danger of ice” message are displayed for 10 seconds in the top right of the display.

When they are displayed, the symbol and message appear instead of the outside temperature; after 10 seconds, the outside temperature is displayed again and the “snow” symbol appears next to it as long as the outside temperature remains 6 °C (43 °F) or below.

Speed limit setting and “Speed limit exceeded” message

The MENU screen page can be used to set a speed limit in the range 30 - 250 km/h (17 - 155 mph) with 5 km/h (3 mph) steps which sends a message to the driver when exceeded. To set the speed limit, call up the MENU screen page by pressing the **UP** button when the MAIN screen page is activated. Select the options “Vehicle Config.” and “Speed Limit” (the only menu function that is configurable while the vehicle is in motion). To set the value, use the **UP** and **DOWN** buttons.

When the minimum limit of 30 km/h (18.6 mph) is reached, press the **DOWN** button again to deactivate the function or press the **UP** button after reaching the maximum speed of 250 km/h (155 mph). The function is normally deactivated (OFF).

When the set limit is exceeded, the driver is informed in the following way:

The symbol showing the set limit and a “speed limit exceeded” message appear in the top right of the display for 10 seconds accompanied by an acoustic signal. Once the warning cycle has ended, the message disappears whereas the symbol continues to be displayed next to the outside temperature until the speed decreases to 5 km/h (3 mph) below the set limit.

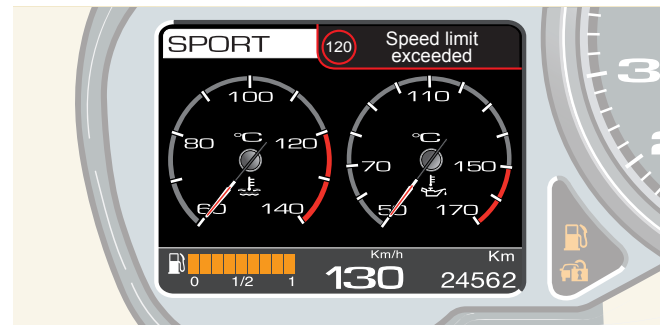



Parking sensors (optional)

To help the driver when parking, the vehicle can be fitted on request with four sensors in the rear bumper (rear parking sensors), or four sensors in the front and rear bumpers (front and rear parking sensors).

Warning



The system will only operate correctly if the sensors on the bumpers are free of mud, dirt, snow or ice.

When approaching obstacles in front of or behind the vehicle, the parking sensors inform the driver of the distance between the vehicle and the obstacle by way of acoustic signals, which become more frequent as the obstacle approaches, and visual signals in area **B** of the left TFT display (see page 85). By supplementing the driver's direct visual information with that provided by the system acoustic signals and visual warnings, potential collisions can be avoided when parking.

Warning



It is the driver, however, who holds full responsibility for parking manoeuvres and other potentially dangerous situations. The system has only been designed as an aid during parking manoeuvres, since it detects obstacles that are outside the driver's range of visibility.

Use of the sensors therefore does not mean that the driver can be less careful and attentive and not watch out for persons and obstacles during parking manoeuvres.

The rear parking sensors are automatically activated when the key is in position **II** and reverse gear is engaged. When the rear sensors are activated, an acoustic signal warns the driver that the system has been activated. If the vehicle is also equipped with front sensors, these can be activated or deactivated by pressing the relative button on the roof panel (see page 129).

“Stop and Go” function

The “Stop & Go” function, available on vehicles with front and rear parking sensors, automatically activates the front sensors when vehicle speed is 10 km/h (6 mph) or below. This system has been designed to assist the driver in certain traffic conditions (e.g. tailbacks) and signals when the minimum distance is reached between the vehicle and the vehicle in front.

To activate or deactivate the system, call up the MENU screen page, select the items “Car setup”, “Parking sensor”, and select one of the two options, “STOP&GO ON” and “STOP&GO OFF”.

Indication of obstacles

The parking sensor system emits acoustic signals as soon as an obstacle is detected which become more frequent as the obstacle approaches. The acoustic signal stops immediately if the distance from the obstacle increases whereas the tone cycle remains constant if the measured distance from the central sensors remains unchanged.

The vehicle symbol and sensor detection zones appear on the left TFT display: these zones indicate which part of the vehicle is approaching an obstacle (if front or rear and if left, right or central) and the distance from the obstacle (maximum, medium or minimum).

3



If an obstacle is detected at maximum distance in the central front part, it will be displayed as shown below (green).

If an obstacle is detected at medium distance in the central front part, it will be displayed as shown below (orange).

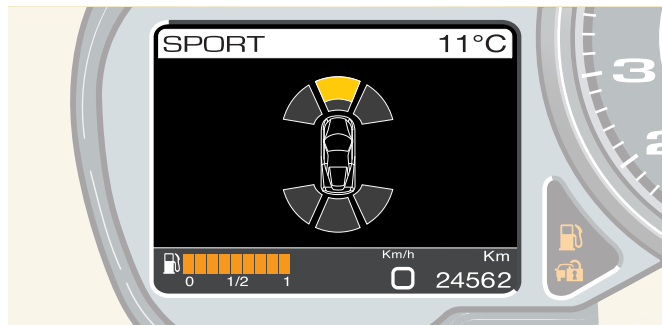
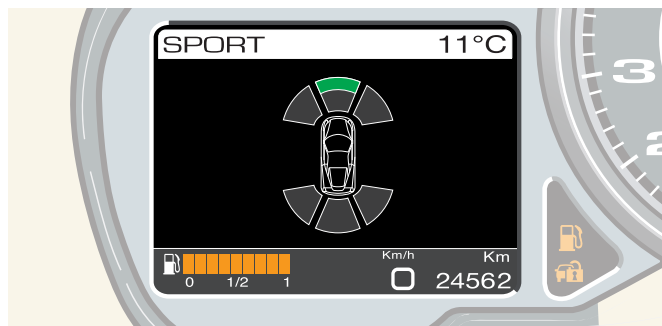

If an obstacle is detected at minimum distance in the central front part, it will be displayed as shown below (red).

The maximum, medium and minimum distances between the vehicle and an obstacle, represented graphically by the colours green, orange and red, are different for the front and rear parking sensors:

Rear sensors:

Maximum distance (green): 80 to 70 cm - 31 to 28 in.
(150 to 70 cm - 59 to 28 in. in central zone)

Medium distance (orange): 69 to 41 cm (27 to 16 in.)

Minimum distance (red): 40 to 0 cm (16 to 0 in.).

Front sensors:

Maximum distance (green): 73 to 53 cm - 29 to 21 in.
(110 to 70 cm - 43 to 28 in. in central zone)

Medium distance (orange): 52 to 31 cm (20 to 12 in.)

Minimum distance (red): 30 to 0 cm (12 to 0 in.).

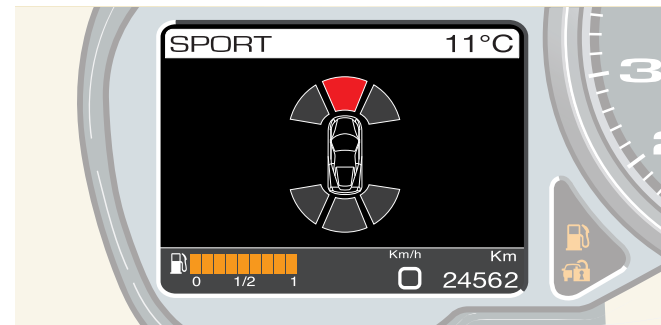



If the front sensors are deactivated or not present, the display does not show the symbols in the front. In the same way, if front sensors are fitted and the rear ones are not activated, the display only shows the symbols in the front. If all the sensors are activated, the system can give several pieces of information at the same time: if an obstacle is detected at a maximum distance in the front central part and at a minimum distance in the rear right part, it will be displayed as shown below.

If the parking sensor system symbols are being displayed and an event occurs that needs to be displayed as an icon and/or special message, the symbol is moved from the centre of the display to the right as shown below.

Cleaning the sensors

When cleaning the sensors, be very careful not to scratch or damage them and avoid using dry, rough or hard cloths. The sensors must be washed with clean water and car shampoo added if necessary. In car washes that use steam jet or high pressure water cleaning equipment, quickly clean the sensors keeping the nozzle at a distance of at least 10 cm (4 in.). For the repainting of bumpers or retouching the paintwork in the sensor area, contact the FERRARI SERVICE NETWORK. If paint is applied incorrectly, it may prevent the parking sensors from working properly.

3

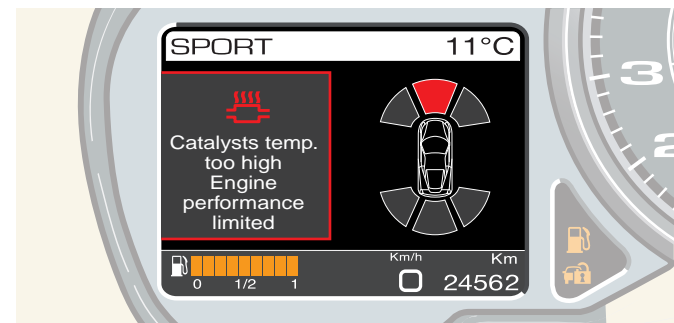
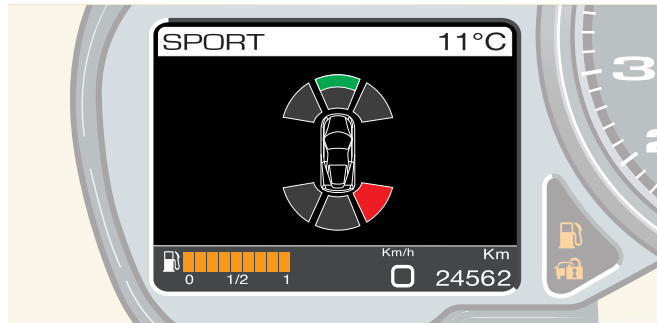



Indication of parking sensor failure

The system ECU checks all the components each time the reverse gear is engaged. If at least one parking sensor is faulty, the special symbol (see page 108) is displayed on the left TFT display together with the message “Parking sensor failure. Warning! Possible obstacles” accompanied by an acoustic signal.

Important note



The sensors are able to detect obstacles with reasonably large, even surfaces (e.g.: poles with diameters of over 60 mm (2.4 in.), walls, barriers, trees). Detection is not optimum with obstacles with sharp projections or uneven surfaces.

Important note



During parking manoeuvres, always take the utmost care since obstacles may be located above or below the sensors.

Important note



Objects placed close to the rear part of the vehicle are not always detected by the system and may therefore damage the vehicle or be damaged themselves.

Important note



The signals sent by the sensors may also be affected by damage to the sensors caused by dirt, snow or ice on the sensors or by ultrasound systems (e.g. pneumatic brakes on lorries or pneumatic drills) in the vicinity.

Warning



However, the driver has full responsibility for parking manoeuvres and in other potentially dangerous situations. The system has been designed only as an aid during parking manoeuvres, since it detects obstacles that are outside the driver's range of visibility. The sensors are therefore not a substitute for the driver's care and attention when parking and checking for the presence of persons or objects.



Fault display

Fault displaying logic

When a fault occurs, the corresponding warning light (if present) comes on on the panel whereas a description of the fault (if available) and the relevant symbol (if available) are displayed on the left TFT display. The message appears on the display at the same time as the warning light (if present) comes on and the main screen page that is displayed at that moment is reduced.

The fault remains on the display for 20 seconds. When the display cycle ends, if the fault does not have a special warning light on the panel, the symbol remains minimised in area **D** of the display (see page 85) until the cause of malfunctioning has been resolved. In area **B** the main screen page is displayed in “maximum” size.

When the display cycle ends, if the fault has a special warning light on the panel, the screen page prior to the anomaly is displayed again, and the symbol is not minimised in area **D**.

The warning light on the panel stays on until the cause of malfunctioning has been resolved.

If the fault is resolved within 20 seconds, it remains displayed and the warning light remains lit for 2 seconds.

“ESCAPE” function

Displaying a fault on the screen can be interrupted by pressing and quickly releasing the OK button with “ESCAPE” function. When the OK button is pressed, the screen page that was displayed prior to the event reappears. If the fault does not have a special warning light on the panel, the symbol remains minimised in area **D** until the cause of malfunctioning has been resolved.

3

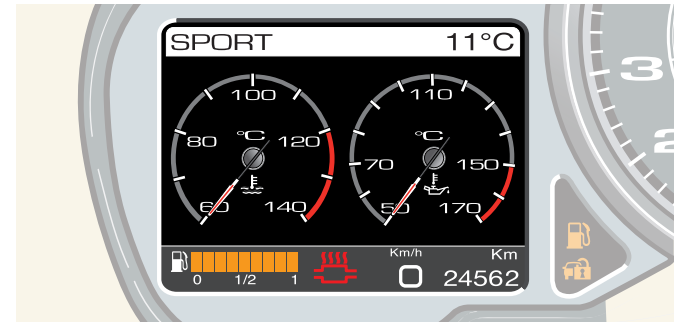
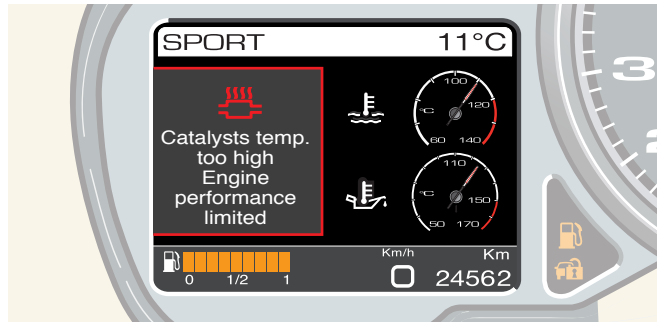



Fault priority levels

The simultaneous display of several faults follows a logic that depends on the priority level assigned to it:

Priority level 0 - Extremely critical fault

Priority level 1 - Critical fault

Priority level 2 - Non-critical fault.

When several fault events occur at the same time, faults with priority level 0 are displayed first, followed by priority level 1 and then priority level 2. The information on the various faults is displayed in turn for 5 seconds each. In any case, the total display time for each fault is never less than 20 seconds.

If a fault message with priority level 1 or 2 is being displayed, the priority level 2 message is only displayed once the priority level 1 message has been displayed for at least 2 seconds. If, on the other hand, another new priority level 0 fault occurs, this is displayed immediately.

Indication of failure of turn indicators and running lights

A failure of the running lights (front and/or rear) and turn indicators (front and/or rear) is indicated in the same way as other faults but the vehicle symbol with the faulty running light or turn indicator indicated in red is displayed together with a description of the failure instead of the “External lights failure” symbol (see page 105). When the display cycle ends or the **OK** button with “ESCAPE” function has been pressed, the “External lights failure” symbol is minimised.

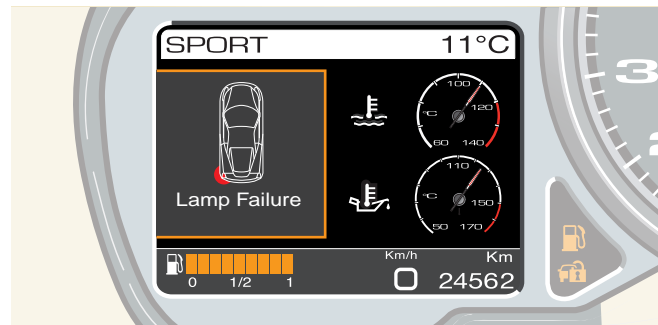



“Doors, engine or luggage compartment lid open” function display



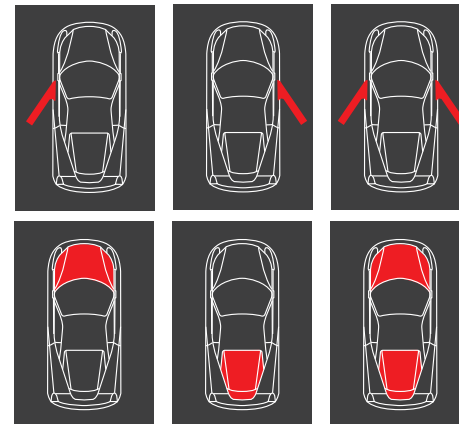
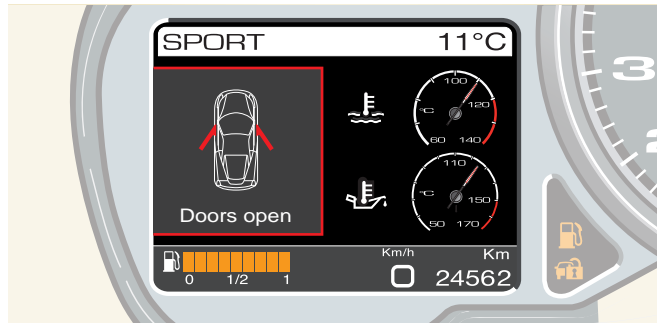

If one or more doors or the engine and/or luggage compartment lid are open, the vehicle symbol appears on the display and indicates which doors or lids are open together with a special message. If the vehicle is in motion, an acoustic signal is also emitted. When the display cycle ends or the **OK** button with “ESCAPE” function has been pressed, the special symbol is minimised (see page 101).

3











List of left hand TFT display symbols and instrument panel warning lamps

TFT Warning light	Description and warnings
 orange	<p>Alarm system failure Indicates a fault in the alarm system (priority level 1). The system is not programmed (priority level 2). Failure and system not programmed (priority level 1).</p>
 orange	<p>Alarm system failure (priority level 2). Break-in attempted (priority level 2).</p>
 orange	<p>Fuel reserve Indicates that the fuel level is too low (priority level 2).</p>
 red	<p>Battery conditioner connected When the instrument panel is on, it indicates that the battery conditioner is connected (priority level 0).</p>
 orange	<p>Inertia switch Indicates activation of the inertia switch following an accident and the resulting cut-out of the fuel supply (priority level 0).</p>

The hazard warning lights are also automatically activated.

 red	<p>Alternator failure If there is a fault in the recharging system (priority level 1).</p>
 orange	<p>Low windscreen washer fluid level Indicates a low level of washer fluid in the windscreen washer tank (priority level 2).</p>
 red	<p>Oil temperature Indicates that the oil temperature is too high (priority level 0).</p>
 orange	<p>Adaptive headlights failure Symbol and warning light in flashing mode indicate there is a failure in the adaptive headlight system (priority level 2).</p>
 orange	<p>Windscreen wiper motor failure Indicates a windscreen wiper motor failure (priority level 2).</p>
 red	<p>Engine coolant temperature Indicates that the engine coolant temperature is too high (priority level 0).</p>

Turn off the engine and contact the FERRARI SERVICE NETWORK.

Turn off the engine and contact the FERRARI SERVICE NETWORK.



red



Oil pressure

red Indicates that the engine oil pressure is too low (priority level 0).

Turn off the engine and contact the FERRARI SERVICE NETWORK.



A flashing warning light indicates an engine oil pressure sensor failure (priority level 2).



orange



Engine diagnostic system (EOBD) failure

orange While the engine is running, this indicates a fault in the emission control system and in the ignition/injection system (priority level 0).

Turn off the engine and contact the FERRARI SERVICE NETWORK.

After turning the ignition key to position II, it remains on for a self-check for a few seconds after the engine has started.



green

Running lights

When the running lights or low beams are turned on.



orange

Stop lights failure

Indicates a system failure or blowing of the STOP light bulb (priority level 2).



orange

External lights failure

Indicates a system fault or blowing of a bulb in the running, turn indicator or rear fog lights (priority level 2).



orange

Number plate lights failure

Indicates a system failure or blowing of the number plate light bulb (priority level 2).



orange

Rear fog lights

When the rear fog lights are turned on.



orange

Twilight sensor failure

Indicates a twilight sensor failure (priority level 2).



blue

High beams

When the high beams are turned on.

When the high beams are used to flash.



green

Right turn indicator

When the right turn indicators are activated.



green

Left turn indicator

When the left turn indicators are activated.



green

Hazard warning lights

The left and right hand turn indicator lights flash simultaneously if the hazard warning lights are activated.

3



red

Catalytic converter temperature

Indicates that the catalytic converter temperature is too high: stop the vehicle (priority level 0).

Contact the **FERRARI SERVICE NETWORK**.



orange

Indicates that the catalytic converter temperature is very high: reduce speed until the symbol goes out (priority level 1).

Indicates a failure of the catalytic converter temperature sensor (priority level 0).



orange

Checking the engine oil level

Indicates a low engine oil level (priority level 0).



orange

Seat heating

Indicates that heated seat function is enabled (remains displayed for 5 seconds).



orange

Power steering failure

Indicates that the power steering system is inefficient (priority level 2).

Contact the **FERRARI SERVICE NETWORK**.



green



green

Cruise Control

Indicates that the Cruise Control has been activated/deactivated.



orange



orange

ABS

Indicates an ABS system failure (priority level 1).

The standard braking system is still functioning. Contact the **FERRARI SERVICE NETWORK**.



orange



orange

ESC off

Symbol and warning light indicate that the ESC system has been deactivated (priority level 1).

The symbol is displayed for 5 seconds together with the “ESC off” message.



orange



orange

ESC system failure

Indicates a fault in the ESC system (priority level 1).

Warning



Stop the vehicle avoiding sharp braking. Stop driving and contact the **FERRARI SERVICE NETWORK** immediately.

Warning



The vehicle can still be driven at low speed (max. 40 km/h - 25 mph) to clear the road.



orange

ESC system activation (flashing warning light)

Indicates that the ESC system has been activated (priority level 1).



orange

CCM brake discs worn

Indicates that the carbon ceramic brake discs are worn (priority level 2).

Contact the **FERRARI SERVICE NETWORK**.



orange



orange

TPMS

Indicates a puncture in one or more normal type tyres (priority 0).

With the warning light in flashing mode for a maximum of 90 seconds after which it remains on in fixed mode, it indicates:

A failure in the TPMS (priority level 2).

TPMS temporarily inactive (priority level 2).

TPMS inactive (priority level 2).

TPMS not calibrated (priority level 2).



red

Doors/front and rear lids open

The symbol, which is minimised, indicates that one or more doors and/or lids are open.



red



red

Airbag system failure

Indicates a system failure (priority level 0).

With the warning light in flashing mode, it indicates that the airbag test cycle has not been completed (priority level 0).

Contact the **FERRARI SERVICE NETWORK**.



red

Driver-side seat belt not fastened

Indicates that the driver-side seat belt has not been fastened (priority level 0) together with an acoustic signal lasting 90 sec.



red



red

Passenger-side seat belt not fastened

Indicates that the passenger-side seat belt is not fastened (priority level 0).



Speed limit exceeded

Indicates that the speed set by the driver has been exceeded (priority level 2), the figure shown indicates the set speed.



orange



red

E-Diff system failure

Indicates an electronic differential failure (priority level 1).



red



red

Brake malfunction

Indicates that the brake fluid level is low (priority level 0).

Indicates an EPB (electric parking brake) failure (priority level 0).

Indicates an overhaul of the Parking Brake system (priority level 0).





red



red



orange

Indicates an EBD system failure (priority level 0).



orange

Rain sensor failure

Indicates a rain sensor failure (priority level 2).



orange

Suspension control system failure

Indicates a malfunction in the suspension control system (priority level 2).

Contact the FERRARI SERVICE NETWORK.



green

Front Lift system status

When on in fixed mode, it indicates that the Front Lift system is activated (vehicle raised).

When on in flashing mode, it indicates that the Front Lift system is being operated (activation or deactivation cycle).



orange

Front Lift system failure

Indicates a Front Lift system failure (priority level 1).



orange

Generic failure

Indicates an airbag warning light failure (priority level 2).

Indicates a Manettino failure (priority level 1).

Indicates a failure in the electronic system (priority level 2).



green

TPMS

Indicates that calibration of the TPMS has been activated.



red



Brake pad wear

Indicates excessive wear of the brake pads (priority level 2).



orange

Parking sensor failure

Indicates that the parking sensor system is faulty (for vehicles equipped with this system) (priority level 2).



green

Scheduled Maintenance (Service)

Indicates the Scheduled Maintenance deadline.



orange

AVH system

Indicates an AVH system failure (priority level 0).



red

Parking brake

Indicates that the parking brake is applied.



red



Gearbox failure

Indicates a system failure (priority level 1).

Contact the FERRARI SERVICE NETWORK.



Ice hazard

Indicates that the outside temperature is 3 °C (38 °F) or lower, highlighting the risk of icy road surfaces.

Drive carefully in these conditions and slow down since tyre grip is significantly reduced.

Warning



In this condition, activate the “WET” driving mode.



orange

Stop&Start on/Stop&Start system warnings

Together with a special message, it indicates:

Stop&Start system on.

Stop&Start system active.

Stop&Start system not available or temporarily deactivated.



orange

Stop&Start off

Indicates that the Stop&Start system has been deactivated.



orange

Stop&Start failure

Indicates a failure in the Stop&Start system (priority level 1).



red

Stop&Start failure

Indicates a failure in the Stop&Start system (priority level 0).

Electronic rev counter

The electronic rev counter indicates the engine RPM. The numbers on the dial multiplied by 1000 correspond to the engine RPM in one minute.

Avoid engine speed rates in the red sector.

There is a space to the bottom right of the rev counter for the display which gives information on dual clutch transmission (DCT).

Important note



If the rev counter has a white or yellow background, backlighting is not activated in daytime conditions (i.e. with the running lights off or with the running lights on but with the twilight sensor detecting daytime conditions) to improve visibility of the gauge.

3





Engine RPM LED on steering wheel (optional)

The five LEDs on the steering wheel rim (available on request) light up in sequence and inform the driver that the maximum engine RPM has been reached for gearshifting. When 5500 RPM is reached, the first LED comes on; the others come on in sequence when 6,250, 7,000, 7,750 and 8,920 RPM are reached.

The LEDs on the steering wheel can be deactivated using the MENU screen page on the left TFT display (see page 86): call up the MENU screen page, select the items “Car setup” and “RPM on steer” and then select OFF. To reactivate the function, select ON.

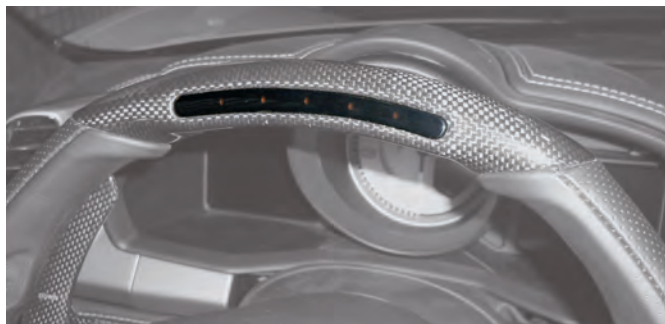

Gearbox display

The display which gives information on dual clutch transmission (DCT) is found to the bottom right of the rev counter; with the ignition key in position II, it displays the following information:

- Gear engaged.
- Indication of “Automatic gearbox” mode.
- Indication of “Auto easy exit” mode.
- Indication of gearbox in “Parking” mode.
- Indication of Launch Control activated.
- Indication of AVH system activated.

Important note



Information on the gearbox is useful in all operating conditions.

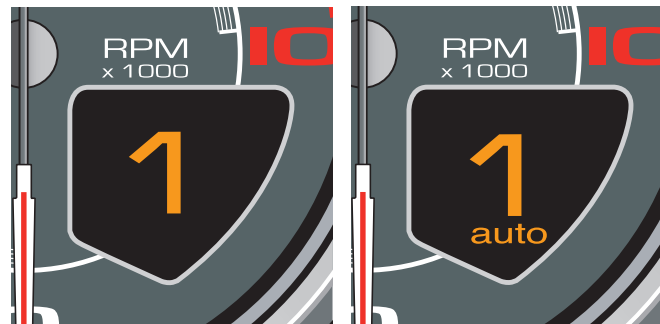



Gear engaged

The gearbox display shows the number or letter indicating the engaged gear in the centre.

- N Neutral
- R Reverse
- 1 1st gear
- 2 2nd gear
- 3 3rd gear
- 4 etc.

When the key is turned to off, the display remains on for at least 3 seconds and displays the engaged gear. If the control panel reads N (Neutral), the letter N is displayed and a buzzer will sound.

Indication of “Automatic gearbox” mode

When the gearbox is used in “automatic” mode (see page 134), the word “auto” appears in the bottom of the gearbox display together with the number or letter indicating the engaged gear.

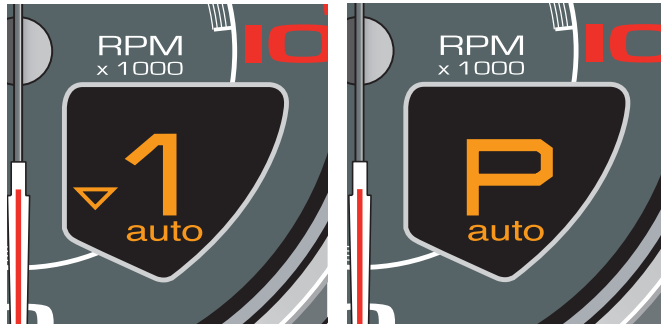

Indication of “Auto easy exit” mode

When the gearbox is used in “Auto easy exit” mode (see page 134), the word “auto” appears in the bottom of the display together with a small “arrow” pointing downwards on the left.

Indication of gearbox in “Parking” mode

When the gearbox is in “Parking” mode, i.e. the Park Lock gearbox locking device is activated (see page 148), the letter “P” appears in the centre of the gearbox display.

Indication of Launch Control activated

When the gearbox is used in “manual” mode and the Launch Control function is requested by pressing the special button on the centre console (see page 149), the word “launch” appears in the bottom of the gearbox display. The word remains while the function is activated.

Indication of AVH system activated

In certain circumstances, when the AVH system is activated (see page 147), the word “HOLD” appears in the top of the gearbox display.

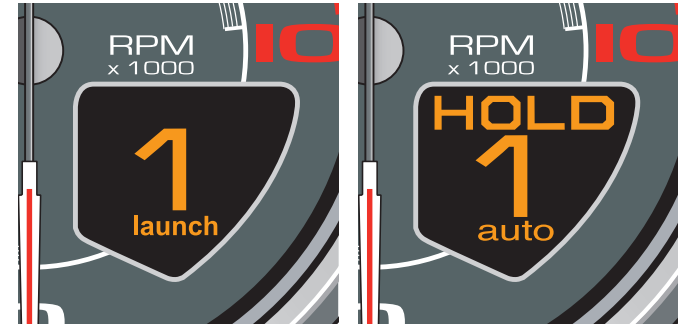

3



Right TFT display

Located on the instrument panel, it performs the following functions:

- it displays the speedometer
- it displays infotainment system information
- it displays the rear parking camera (if present).

The driver can interact with the system by selecting the configuration and setting the parameters using the controls on the dashboard to the right of the steering wheel.

Holding button **A** down switches the infotainment system on and off.

Holding button **B** down allows you to select whether to display infotainment system information or display the speedometer.

USB connection

The USB connector in the centre tunnel console oddments compartment may be used to charge a mobile telephone or any

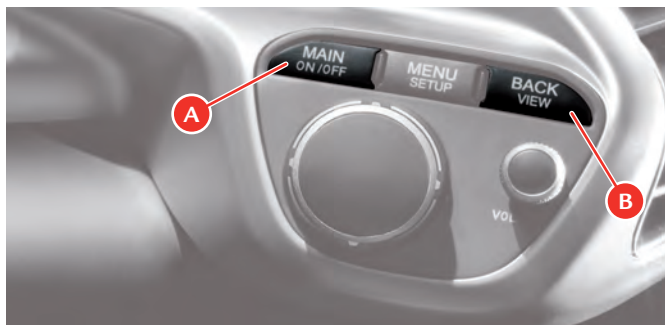

other device with USB charging function, and also functions as an interface with the optional infotainment system (on vehicles equipped with system).

Infotainment system (optional)

The infotainment system includes the following functions:

CD/DVD player with charger mounted in glove compartment, MW/LW/FM radio, 30 GB hard disk drive, USB connection, iPod® connector (optional), satellite navigator (optional), Bluetooth connectivity, voice recognition.

As well as using the commands on the dashboard to the right of the steering wheel, the infotainment system can be controlled using buttons behind the steering wheel.

For further information on the infotainment system, see the “Reference Guide” included in the on-board documentation.

Speedometer display

The speedometer can be displayed on the right TFT display in “Speedometer” or “Digital speed” mode.

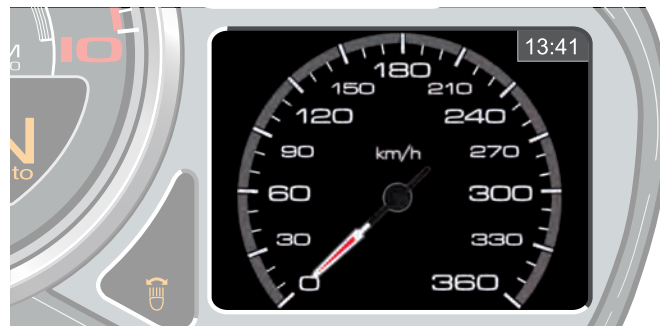



To select the desired display mode, call up the MENU screen page on the left TFT display (see page 86) and select the items “Display setup”, “Display right”.

“Speedometer” screen page

The “Speedometer” screen page indicates the speed by displaying a virtual analogue speedometer.

“Digital speed” screen page

The “Digital speed” screen page indicates the speed in digital form.

Important note



The speedometer is always also displayed in digital form in area **D** of the left TFT display (speed repetition, see page 85).

Time display

By selecting the special item on the MENU screen page of the left TFT display, you can activate/deactivate the time display in the top right of the “Speedometer” and “Digital speed” screen page. The time is displayed approximately 10 seconds after key-on.

“Rear Parking Camera” screen page (optional)

If the vehicle has a rear parking camera (optional), the “Rear Parking Camera” screen page is automatically displayed on the right TFT display when reverse gear is engaged. This screen page, which continues to be displayed until reverse gear is disengaged, shows the field of vision of the camera mounted on the rear bumper and helps the driver when parking.

The image is overlaid with static green, yellow and red grids indicating the distance of obstacles within the camera's field of vision: the area within the red grid represents a zone from 0 to 60 cm (0-24 in.), the yellow grid represents a zone from 60 to 120 cm (24-47 in.) and the green grid represents a zone from 120 to 200 cm (47-79 in.).

3





Cruise Control (optional)

The Cruise Control is an electronic device designed to help the driver drive at a constant speed of between 30 km/h and 213 km/h (19 -132 mph) without having to keep the accelerator pedal pressed.

Important note



We recommend only using the Cruise Control on long, dry stretches of road requiring few gear changes (e.g. motorways). Do not use the device for city driving.

Important note



PIT SPEED is a term taken from the motor sports world used by **FERRARI** to indicate the speed memorised using the device and does not endorse inappropriate behaviour on the road which does not comply with Traffic Regulations.



Activating Cruise Control

To activate the Cruise Control, hold down control **A** for longer than 0.3 seconds.

When the system is activated, a warning lamp lights on the instrument panel (see page 106), and the message “Cruise Control ON”, together with the specific symbol, are shown for 5 seconds on the left hand TFT display.

The Cruise Control can only be activated with the 4th, 5th, 6th or 7th gear engaged.

When going down slopes with the device on, the vehicle speed may be slightly higher than the memorised speed.

Memorising the speed

Proceed as follows:

- with the device activated, bring the vehicle to the desired speed by pressing the accelerator pedal
- turn control **A** clockwise (+) for at least 3 seconds and then release it: the speed of the vehicle is memorised and you can release the accelerator pedal.

If necessary, you can accelerate by pressing the accelerator pedal: when the pedal is released, the vehicle will return to the previously memorised speed.

Resetting the memorised speed

If the device has been turned off by pressing the brake pedal, the memorised speed can be reset as follows:

- gradually accelerate until the vehicle reaches a speed which is close to the memorised speed
- quickly press control **A**.



Increasing the memorised speed

This can be done in two ways: by pressing the accelerator and memorising the new speed reached or by turning control **A** clockwise (+).

One turn of the control corresponds to an increase in speed of about 2 km/h (1.2 mph); if the control is kept turned on the other hand, the speed continually increases.

Reducing the memorised speed

This can be done in two ways: by deactivating the device and then memorising the new speed or by turning control **A** counterclockwise (-).

One turn of the control corresponds to a decrease in speed of about 2 km/h (1.2 mph); if the control is kept turned on the other hand, the speed continually decreases.

Deactivating Cruise Control

Hold down control **A** for longer than 0.3 seconds or turn the ignition key to position **0**. The device is also automatically deactivated by pressing the brake pedal.

When it is deactivated, the warning light on the instrument panel goes out and a “Cruise Control OFF” message accompanied by a special symbol appears on the left TFT display for 5 seconds.

Warning



While driving with the Cruise Control activated, do not put the vehicle into “N” (neutral).

Warning



If the Cruise Control is malfunctioning or faulty, deactivate the device and contact the **FERRARI SERVICE NETWORK**.

3



Controls on the steering wheel

Start button

Press the ENGINE START button **A** to start the engine. When the engine has started, release the ENGINE START button.

Do not hold the ENGINE START button down for a long time.

For more information on starting the engine, see page 130.

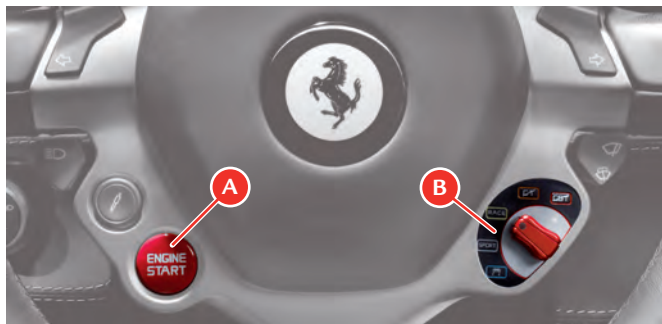

Driving mode control switch “Manettino”

The driver can select the desired driving mode by using the “Manettino” **B**.

The driving mode selected does not exempt the driver from complying with the rules of safe driving.

Important note



In the event of a failure of one of the onboard systems, signalled by the special symbol on the left TFT display, the Manettino” moves to a “recovery” position, but still allows the vehicle to be driven. In these cases, contact the FERRARI SERVICE NETWORK.

Driving modes that can be selected with “Manettino”

WET mode

This is the maximum safety driving mode. Recommended in low grip conditions.





SPORT mode

This is the ideal setting for vehicle performance recommended for everyday driving.

RACE mode

This mode offers maximum performance and stability in high grip conditions and is particularly suitable when using the vehicle on track.

CT OFF mode

When this mode is selected, the F1-Trac traction control system is disabled whereas stability control remains active. This setting is used on the racing track.

ESC OFF mode

This mode allows the driver complete freedom and control of the vehicle for track use. No electronic system other than the E-Diff controls vehicle stability.

Warning



In low- to medium-grip conditions (e.g. wet, icy, sandy roads), do not deactivate the ESC system.

For further information on the driving modes that can be selected, refer to the paragraph “Driving using the driving mode control switch” on page 140.

Active aerodynamics (DRS)

The active aerodynamics system makes it possible to use different vehicle configurations for bends, where maximum downforce is essential, and for straights, where minimum drag is needed.

There are three passive aerodynamic elements at the front of the vehicle - two vertical flaps and a horizontal flap in the undertray. At relatively low speeds, all the flaps are closed, and air flow is directed to the radiators to provide adequate engine cooling functionality. Above 170 km/h, the vertical flaps open, modifying the air flow to reduce the volume fed to the radiators and, as a result, reduce drag. Above 220 km/h, the horizontal flap lowers to reduce front downforce. This shifts the overall aerodynamic balance towards the rear of the vehicle.

3

Important note



The active aerodynamics are disabled in WET mode, and in any driving mode when the external temperature is below 3 °C.





The rear flaps have two configurations:

- high downforce - the flaps are raised, and the air flow is kept close to the diffuser,
- minimum drag - using sensors and a specific algorithm, the system lowers the flaps to 17°, stalling the diffuser and reducing drag.

The DRS icon at the top of the left hand TFT display indicates the state of the active aerodynamics system (DRS).

When the system is deactivated, the icon shows a raised flap in grey.



When the system is active, the icon shows an extended flap in black.





If the ECU identifies a system fault impeding DRS activation, the following pop-up is shown on the display:



After 20 seconds, the pop-up is reduced to an icon at the bottom of the display, and the fault is indicated by the DRS icon displayed in orange.



If the fault involves the electronic control system, the following pop-up is displayed:



After 20 seconds, the pop-up is reduced to an icon at the bottom of the display, and the fault is indicated by the warning icon displayed in orange.



Side Slip angle Control (SSC)

In RACE and CT OFF manettino modes, the electronic slip angle control system (Side Slip angle Control - SSC) ensures the maximum grip possible in relation to the driving conditions.

The system uses specific sensors and an algorithm to determine lateral acceleration, yaw angle, steering wheel angle and speed. The SSC system analyses the vehicle slip angle in real time and compares it against ideal reference values to optimise engine torque delivery (through the F1-Trac traction control system, see page 60) and more effectively distribute the torque transmitted through the differential across the two drive wheels (via the E-Diff electronic differential, see page 60).





Suspension damping delink button

By pressing button **C** on the left of the steering wheel, the driver can choose to separate the suspension damping control from the logic of the “Manettino” driving mode control switch.

For further information, see page 144.

Horn control

The horn sounds when you press on the horn symbol on the steering wheel rim.





“UP” shift paddle

Pull the right-hand **UP** paddle towards the steering wheel to shift gears up.

“DOWN” shift paddle

Pull the left-hand **DOWN** paddle towards the steering wheel to shift gears down.



Windscreen washer/wiper stalk

Important note



The windscreen wipers and washer only work when the ignition key is in position **II**.

The windscreen wipers and washer are operated using lever **A** on the steering wheel: the lever must be pressed towards the dashboard or pulled back according to the function you require.

The windscreen wipers have 4 different speeds:

- OFF** Windscreen wipers stationary.
- AUTO** The rain sensor adjusts the windscreen wiper timing to the intensity of the rain.
- 1** Slow continuous operation.
- 2** Fast continuous operation.

3





With the wipers stationary (**OFF**), quickly pressing lever **A** towards the dashboard activates the windscreen wipers in **AUTO** speed.

With the wipers on, quickly pressing the lever towards the dashboard increases windscreen wiper speed (from **AUTO** to **1**, from **1** to **2**).

With the wipers set to **AUTO** or **OFF**, holding the lever towards the dashboard activates maximum speed (**2**). With speed **1** or **2**, on the other hand, the windscreen wipers stop.

With the wipers on, quickly pulling lever **A** back decreases windscreen wipers speed (from **2** to **1**, from **1** to **AUTO**, from **AUTO** to **OFF**).

With the wipers stationary, quickly pulling the lever back activates fast temporary operating of the wipers (antipanic wiping).

The windscreen wiper speed is indicated in the top of the left TFT display as shown in the figure below.

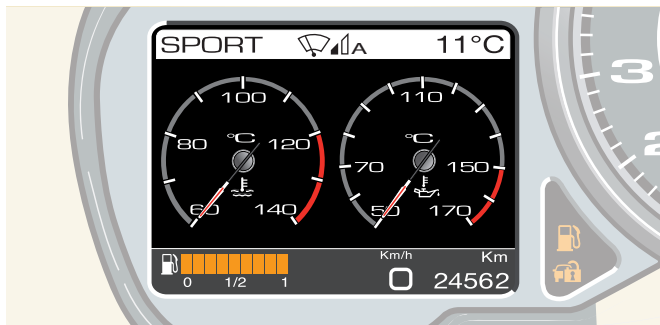

Important note



Windscreen wiper operating is always guaranteed even if there is an electronic system failure. If there is a failure, the windscreen wipers can be activated by pressing lever **A** and deactivated by pulling it back.

If there is a particularly serious failure, operating may not be automatically maintained: if this is the case, the windscreen wipers can be kept activated by holding down lever **A**.

Windscreen washer

To activate the windscreen washer, keep lever **A** pulled. When the lever is released, the windscreen wiper returns to the preset speed.

Warning



Do not start the windscreen washer during the cold months until the windscreen has warmed up. If it has not warmed up, the liquid could freeze on the glass and interfere with visibility.

Headlight washer

The headlight washer is activated automatically when the windscreen washer is operated and the low beams are on. The headlight washer and windscreen washer share the same fluid tank and a low fluid level is indicated by the relative symbol on the left TFT display.



Rain sensor

The rain sensor automatically adjusts the windscreen wiper timing to the intensity of the rain. The system is activated by moving the windscreen wiper to **AUTO**.

When operating automatically, the wiper speed ranges from a minimum intermittent setting (one wipe every 5 seconds approx.) when the windscreen is damp to fast continuous operation in heavy rain.

Important note



The rain sensor function is deactivated by turning the ignition key to position **0** and leaving the windscreen wiper selector set to **AUTO**. To reactivate the system at the next key-on, set the wipers to **AUTO** by quickly pressing the lever **A** towards the dashboard.

Warning



Before cleaning the front windscreen (for example in service stations) make sure the rain sensor is deactivated or that the key is in position **0**. The rain sensor must be deactivated also when washing the vehicle by hand or in automatic car washes.

In case of ice or snow on the front windscreen, do not activate the rain sensor to avoid damaging the wiper motor and/or blades.

Rain sensor failure

If there is a rain sensor failure, indicated by a special symbol on the left TFT display (see page 108) while the windscreen wiper is set to **AUTO**, the wipers will be set to intermittent operation with one wipe every 1 second approximately. If this is the case, we recommend that you deactivate the rain sensor and turn on the wipers, if necessary, in continuous mode.

Important note



If this occurs, contact the **FERRARI SERVICE NETWORK** as soon as possible.

3



Lighting

The external lights and turn indicators only work when the ignition key is in position II.

The external lights can be switched on and off manually or automatically, depending on the ambient light.

Light switch

The switch **A**, on the dashboard to the left of the steering wheel, can be set to five different positions:

- 0** Lights off
- Running and number plate lights on (*)
- Low beams on (*)
- Parking lights
- AUT** Automatic operation of the external lights according to ambient light.

(*) The relative warning light on the instrument panel comes on.



High beams

To turn on the high beams when the light switch **A** is set to , push lever **B** on the steering wheel towards the dashboard.

When the high beams are on, the relative warning light on the instrument panel comes on.

Then push lever **B** towards the dashboard or pull it back to turn off the high beams and turn on the low beams.

Flashing the headlights

The headlights can be flashed by pulling back the left-hand lever **B**.

Flashing also occurs with lights off if the ignition key is set to II.

The high beams are used for flashing.





Important note



Follow the Road Regulations of the country you are travelling in for using the high beams.

Parking lights

The parking lights work only with the ignition key in position **0** or with the key removed.

They are activated by turning the light switch **A** to position **P**.

When the parking lights are on, the warning light illuminates on the instrument panel .

When the parking lights are on, press and hold one of the two turn indicator buttons **C** on the steering wheel (see page 124) for more than 0.5 seconds to turn on the single-side parking lights on the corresponding side; press the same turn indicator again for more than 0.5 seconds to go back to full parking lights.

When the partial parking lights are on (on only one side of the vehicle), the running light warning light  turns off whereas the vehicle symbol indicating which parking light is on (left or right) is displayed on the left TFT display for 10 seconds.

When the light switch **A** is turned to **AUT** and the ignition key is in position **II**, the running lights, low beams and number plate lights turn on and off automatically according to the ambient light.

Important note



The high beams can only be activated manually by pulling back the left-hand lever **B**.

Important note



If the high beam control is activated, the high beams will turn on every time the lights are activated automatically. We recommend therefore that you turn them off every time the twilight sensor deactivates the external lights.

3

Warning



If there is fog during the day, the running lights and low beams will not be turned on automatically. The driver must always be ready to turn on the lights manually and also the rear fog lights, if necessary.

Important note



After automatic activation of the external lights, it will always be possible to turn on the rear fog lights manually. When the external lights are deactivated automatically, the rear fog lights are also turned off (if active) automatically. Therefore, if necessary, the driver will have to turn on the rear fog lights manually upon the next automatic activation.



Warning



The driver is always responsible for turning on the external lights, depending on the ambient light and in compliance with the regulations in force in the country of use. The automatic system for turning on and off the external lights must be considered an aid for the driver. If necessary, turn the lights on and off manually.

Twilight sensor

The twilight sensor is comprised of a global sensor which measures the ambient light upwards.

In the event of sensor failure, the system switches on low beams and running lights, regardless of the daylight conditions; a failure message will appear on the instrument panel display.

The failure indication will be displayed as long as the light switch is turned to AUT.

If this occurs, we recommend that you deactivate the automatic system and turn on the external lights manually if necessary.

Important note





If this occurs, contact the **FERRARI SERVICE NETWORK** as soon as possible.

Day lights

The LEDs on the headlights serve as front turn indicators and day lights. To activate or deactivate the day running lights, call up the MENU screen page on the left TFT display, select the items “Car setup”, “Day lights” and select ON to activate the function and OFF to deactivate it.

Turn indicators

Quickly press the left indicator or right indicator button **C** on the steering wheel to switch on the relevant turn indicator.

The relative warning light  or  on the instrument panel comes on.

The turn indicator goes off when the steering wheel is realigned.

Holding down one of the two **C** buttons (for more than 0.3 seconds) temporarily switches on the relevant turn indicator: it is switched off after 3 flashes (“lane change” function).





Rear fog lights

The rear fog lights are turned on only if the high beams or low beams are on when button **D** is pressed; the relevant warning light **E** on the instrument panel comes on to indicate that they have been turned on.

Important note



Use the rear fog lights only in poor visibility conditions.

Hazard warning lights

Press button **F** to turn on the hazard warning lights. All the turn indicators will start blinking intermittently; these lights will operate with the ignition key in any position.

When the lights are on, the relative warning lights on the instrument panel and the button flash.

To turn them off, press the button again.

3

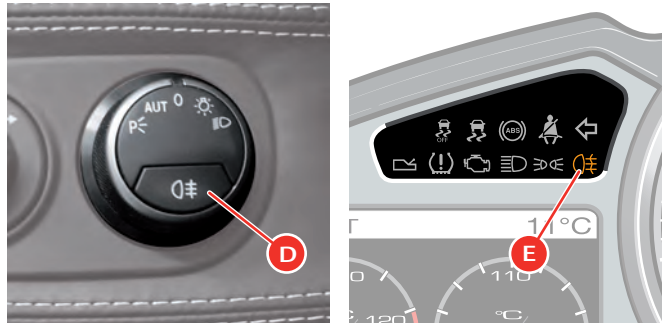



“Follow me home” function

With the “Follow me home” function, the low beams stay lit for a preset period of time once the engine has been turned off and light up the area around the vehicle to help the driver and passengers see their way in the dark.

The function can be manually activated by pressing the high beam/flashing lever **B** (see page 122) when the ignition key is in position **0** or removed, within 3 minutes of switching off the engine (time that is reduced to 30 seconds if the driver-side door is opened). Each time lever **B** is pressed, the period of time that the low beams remain on increases by 30 seconds up to a maximum of 210 seconds.

Each time lever **B** is pressed, the message “Follow me” appears on the left TFT display followed by the preset period of time that the low beams remain on.

AFS2 adaptive headlights (optional)

The AFS2 adaptive headlight system (available on request) enables synchronous movement of the left and right front beams (high and low) and has been designed to illuminate the road better and reduce areas of shadow in the vehicle's trajectory.

The headlights' swivel angle, which ranges from 8° inwards and 15° outwards, is defined by the steering angle.

The AFS2 system also uses a “Dynamic Levelling” device that directs the light beam vertically when accelerating and braking by moving the headlights up to 1.9° upwards when braking and up to 1° downwards when accelerating.

The adaptive headlight system deactivates its corrective action when driving round bends at low speed.



Dome light

When the doors are closed, the dome light **D** on the roof can be turned on or off using the switch **E**.

Switches **F** and **G** turn the driver-side and passenger-side spotlights on and off.

The dome light activates automatically in the following conditions:

- when a door is opened, for approx. 3 minutes
- when all the doors are closed and the key is in position 0, for approx. 10 seconds
- when the key is removed, for approx. 10 seconds
- when the doors are unlocked, for approx. 10 seconds
- when the inertia switch is activated, for approx. 15 minutes.

The dome light deactivates automatically in the following conditions:

- after the preset activation time expires
- when the doors are closed and the key is in position II
- when the doors are locked
- when the inertia switch is reactivated.

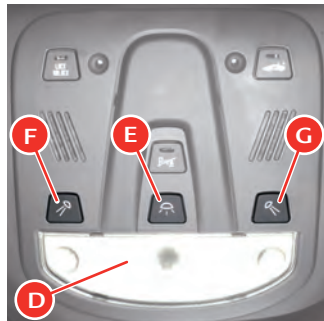

Roof panel controls

Door lock/unlock

Both doors can be locked by activating/deactivating the “LOCK/UNLOCK” **H** button. For further information, see page 72.

Deactivating the anti-lift alarm

Press button **L** to deactivate the anti-lift alarm system. For further information, see page 18.

Front parking sensors (optional)

On vehicles fitted with front and rear parking sensors, the front parking sensors are activated/deactivated by pressing button **M**. When the front parking sensors are activated, the light on the button comes on.

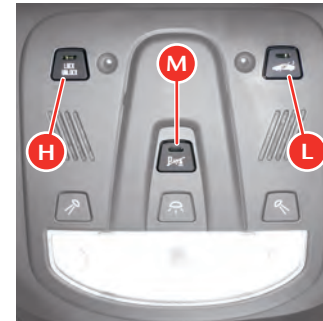

3



Driving the vehicle

Running-in

The latest manufacturing techniques have allowed us to achieve high precision and accuracy levels in the construction and assembly of components. Nonetheless, the vehicle movable parts undergo a settling process, basically during the first hours of operation.

Engine and transmission

Avoid exceeding 5,000 RPM for the first 1,000 km (620 mi).

After starting, do not exceed 4,000 RPM until the engine has warmed up (oil temperature: 65-70 °C / 149-158 °F).

Do not let the engine run at a constantly high speed for a prolonged time.

Warning



BEFORE YOU DRIVE

Check that the seat belts are fastened

Check that the doors are closed

Check that the seat is properly adjusted

Check the rear-view mirror adjustment (central and sides).

Before a trip

Preliminary checks

Check the following at regular intervals and always before long trips:

- tyre pressure and condition
- levels of fluids and lubricants
- condition of the windscreen wiper blades
- proper functioning of the warning lights and external lights.

Important note



In any case, it is advisable to perform these checks at least every 1000 km (620 mi) and always comply with the maintenance schedule.

It is also advisable to:

- clean the glass covers of the external lights and all the glass surfaces
- properly adjust the mirrors, steering wheel, seats and seat belts.

Refilling

Warning



Use unleaded fuel only!

Using leaded fuel would permanently damage the catalytic converters.

For specifications and quantities of lubricants and fluids, refer to the “Refilling” table on page 34.



Starting and driving the vehicle

System start-up

After turning the ignition key to position II (key-on), both TFT displays are activated on the instrument panel and system diagnosis is performed. During diagnosis, which lasts 5 seconds, a check is performed on the warning lights on the panel and the presence of any faults is checked.

If diagnosis detects any errors, they are only displayed once the 5 seconds required for the check have elapsed. The cases listed below are an exception and errors are displayed as soon as the key is turned to on, even during diagnosis:

- Low engine oil pressure (see page 105)
- Inertia switch triggered (see page 104)
- Semi-automatic gearbox safety warnings
- Deactivation of EPB warning (see page 146).

If the next scheduled maintenance deadline is approaching, each time the key is turned to on, information on scheduled maintenance is automatically displayed after diagnosis. For further information, refer to the “Maintenance Schedule” paragraph on page 212.

Finally, each time the key is turned to on, the message for activation of the alarm when an intrusion has been attempted (see page 19) is also displayed (after diagnosis).

Once the system check has been completed, the gearbox display is activated and the letter “P” (Parking) or “N” (Neutral) will be displayed.

Important note



BEFORE YOU DRIVE

If the warning light **A** does not turn off after diagnosis, indicating a fault in the gearbox (which is also indicated by the symbol and specific message on the left TFT display - see page 108), contact the **FERRARI SERVICE NETWORK**.

3

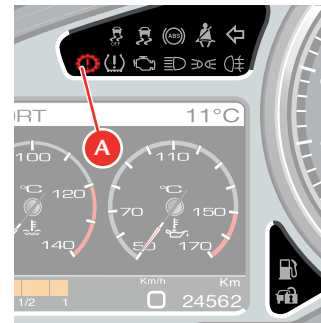



Important note



The vehicle is equipped with an electro-hydraulically controlled gearbox system operated by means of paddles on the steering wheel.

The default setting for the DCT gearbox is always “Automatic” mode (see page 134).

Every time the vehicle is started, the DCT gearbox is in “Auto easy exit” mode (see page 134) unless the vehicle was in “Automatic” mode when the engine was turned off.

To exit the “Auto easy exit” mode operate the **UP** and **DOWN** paddles (while the vehicle is moving) or press the **AUTO** button on the centre console.

Important note



Immediately release the **UP** and **DOWN** paddles or button **R** after the gearbox display shows that the gear has been engaged; a prolonged manoeuvre would cause the gearbox failure warning light to turn on (see page 108) and triggering of the buzzer.

Important note



None of the gears can be engaged if the luggage compartment lid is open or not properly closed. When the vehicle is stationary, with the driver-side door open or not properly closed and the brake pedal released, the system disengages the gear engaged after approximately two seconds.

Starting the engine

Before starting the engine, make sure that the alarm system and all electrical devices with high power absorption are turned off.

- Make sure that the electric parking brake is applied and that the doors are closed.
- Hold the brake pedal down when starting the engine.

Warning



Do not press the accelerator pedal.

- Turn the ignition key to position **II** and wait for the gearbox display to come on.
- Press the **ENGINE START** button (see page 116) and release it as soon as the engine starts.

Do not hold the **ENGINE START** button down for a long time.

If the engine does not start, turn the key back to position **0** and wait for the gear display to go off before retrying.

Warning



Hold the brake pedal down while starting the engine.



If the engine fails to start after several attempts, check for one of the following causes:

- insufficient speed of the starter motor (flat battery)
- ignition device faulty
- electrical contacts faulty
- fuel pump fuses blown.

Warming up the engine

Do not run the engine at high speed until the engine oil temperature has reached at least 65-70 °C (149-158 °F), approximately.

Starting the vehicle

With the engine started, the vehicle stationary and the brake pedal pressed, pull the right-hand “UP” paddle towards the steering wheel to engage 1st gear.

Release the brake pedal and press the accelerator to start off.

With the engine running and the vehicle stationary, you can change directly from 1st or 2nd gear to “R” (reverse) by pressing **R** on the centre console and from reverse to 1st by moving the **UP** paddle.



Warning



If the **UP** and **DOWN** paddles are not working, the message “Depress brake pedal and press LAUNCH to engage gear” will appear on the left TFT display; you can therefore engage the gear by pressing the **LAUNCH** button on the centre console (see page 149) and the brake pedal.

In these cases, the “Launch Control” function is not available.

If the engaged gear was **R**, the **LAUNCH** button must be pressed twice to engage 1st gear.

3

Important note



When reverse is selected, an acoustic safety signal beeps intermittently as long as “R” is engaged.

If the system automatically selects 2nd gear when attempting to shift from **R** to 1st gear, this indicates that 1st gear has jammed. Therefore, this is not a malfunction, as it falls within the system operating logic. For the same reason, when shifting from 1st gear to “R”, the system will automatically engage “N” if the gear has jammed.

During prolonged stops with the engine running, it is advisable to keep the gearshift in “N”.

Important note



If you allow the vehicle to move forward in N, when UP or DOWN is requested, a gear will be engaged that corresponds to the speed of the vehicle.



UP-shifting

Use the right-hand **UP** paddle without releasing the accelerator pedal.

An **UP**-shift request is not accepted when engagement of the requested gear forces the engine to underrev or if an **UP**-shift is already in progress because of engine overrevving.

In any event, it is advisable to:

- Shift gears without releasing the accelerator pedal if pressed.
- Wait until gearshifting has been completed before requesting the next shift, avoiding a rapid sequence of multiple requests.

UP-shifting due to overrevving

The system “automatically” engages a higher gear if the accelerator pedal is pressed and the engine approaches the “runaway speed rate” (overrevving).

Important note



This will not occur when the system is in “RACE”, “CT OFF” and “ESC OFF” driving modes.

DOWN-shifting

Use the left-hand **DOWN** paddle without releasing the accelerator pedal.

A **DOWN**-shift request is not accepted if engagement of the requested gear forces the engine beyond a certain RPM, depending on the gear requested, or if a **DOWN**-shift is already in progress because of engine underrevving.

In any event, it is advisable to:

- Shift gears without releasing the accelerator pedal if pressed.
- If **DOWN**-shifting is requested to start overtaking which requires quick acceleration, press the accelerator pedal just before using the paddle.
- Wait until gearshifting has been completed before requesting the next shift, avoiding a rapid sequence of multiple requests.

DOWN-shifting due to underrevving

- The system shifts down “automatically” if the engine goes below a minimum number of revs (1250 RPM).
- The **DOWN**-shift request from the paddle is ignored if gearshifting is already in progress due to engine underrevving.

Sequential downshifting

During deceleration, with the brake pedal pressed and the ABS system disabled, sequential downshifting can be performed by holding the left-hand “**DOWN**” paddle down.

The sequential gearshifting request is accepted until the second gear is engaged.

This system is only activated when the “Manettino” is set to SPORT, RACE, CT OFF or ESC OFF.



“N” (Neutral) request

With the engine running, pull both **UP** and **DOWN** paddles towards the steering wheel at the same time without pressing the brake pedal to request neutral “N”.

If necessary, “N” can be requested at any speed. Subsequently, if an “**UP**” or “**DOWN**” shift is requested, the system will engage the gear most suited to the speed of the vehicle.

Stopping the vehicle

When the vehicle stops, the system automatically engages **1st** gear unless Neutral has already been requested.

When the vehicle is stationary and the engine is running, hold the brake pedal down until ready to move off again.

Switching off the engine

The engine can be switched off with the gearbox either in “N” or with a gear engaged.

After turning the ignition key from position **II** to position **0**, the gearbox display will remain on for a few more seconds to display the engaged gear. If the gearbox is in “N” a buzzer will sound. Before switching off, the letter “**P**” is displayed on the gearbox display to inform the driver that the Park Lock has been activated.

Warning



Never leave the vehicle with the gearbox in “N”. Always make sure that the letter “**P**” (Parking) appears on the gearbox display.

Warning



Never leave the vehicle with the engine running.

Important note



If the vehicle is not in Parking mode (the letter “**P**” must be displayed on the gearbox display), the key cannot be removed.

3

For information on the Park Lock, see page 148.



“Automatic gearbox” mode

The “Automatic gearbox” mode is enabled/disabled by pressing the **AUTO C** button on the centre console. When the “Automatic” mode is enabled, the word “auto” appears on the gearbox display. To exit the “Automatic” mode, you must press the **AUTO** button until the word “auto” on the gearbox display disappears.

When the “Automatic Gearbox” mode is enabled, the system will automatically UP-shift and DOWN-shift according to vehicle speed, engine revs and the torque/power request of the driver.

When you are in “Automatic” mode, you can however manually shift gears using the **UP** and **DOWN** paddles. The system remains in “Automatic” mode: this is indicated by the word “auto” that remains on the gearbox display in flashing mode when the paddles are used.

When the vehicle is stationary, a “N”, 1st gear or “R” request will not result in a change from “Automatic” to “Manual”.



“Auto easy exit” mode

Every time the vehicle is started, the gearbox starts in “Auto easy exit” mode unless it was in “Automatic” mode when the engine was turned off. In this case, it remains in “Automatic” mode the next time the engine is started.

Activation is signalled by the word “auto” and an arrow ▼ in the gearbox display.

In this mode, the system will automatically UP-shift and DOWN-shift according to vehicle speed, engine revs and the torque/power request of the driver.

To exit the “Auto easy exit” mode and go to “Manual” mode, operate the **UP** or **DOWN** paddle (while the vehicle is moving) or press the **AUTO** button on the centre console.

If the “Automatic” gearbox mode is then requested by pressing the **AUTO** button, the system will apply all the characteristics of the “Automatic” gearbox mode.

Push start

Warning



Push starting is not allowed.



Safe driving

For safe driving, it is essential that the driver be aware of the best driving techniques suited to various circumstances. Always try to prevent dangerous situations by driving with caution.

Before you drive

- Adjust the position of the seat, steering wheel and rear-view mirrors, in order to obtain the best driving position.
- Adjust the backrest so that your chest is upright and your head is as close to the headrest as possible.
- Ensure that nothing (e.g. mat covers, etc.) is blocking the pedals.
- Check that the lights and headlights are working properly.
- Ensure that any child restraint systems (e.g. child seats, cradles etc.) are properly fixed on the passenger seat.
- Your reflexes are quicker if you eat lightly before driving: avoid heavy meals before a trip.
- Do not drink alcoholic drinks before and during the journey.

At regular intervals, check the following:

- Tyre pressure and condition.
- Engine oil level.
- Engine coolant level and system condition.
- Brake fluid level.
- Steering fluid level.
- Windscreen washer fluid level.

While travelling

- Caution is the number one rule for safe driving, which also means you should take other people's behaviour into consideration.
- Follow the Road Regulations in force in the country you are driving in and always respect the speed limit.
- Always make sure that the driver and passengers have their seat belts fastened and that all children are travelling in suitable child seats.
- Good personal physical conditions ensure you can drive long distances safely.

Warning



Driving under the influence of drugs, some medicines and alcohol is dangerous to yourself and others as well as contravening road regulations and legal norms.

Travelling without your seat belt fastened increases the risk of serious injury and death in the event of a collision. Always fasten seat belts and use child seats, if present.

Do not travel with objects lying on the floor, especially in front of the driver's seat: in the event of braking, these could slide under the pedals, making it impossible to brake or accelerate.

Additionally, ensure that any loose floor mats sit correctly.

Water, ice and salt spread on icy roads may deposit on the brake discs and reduce the efficiency of the initial braking.

3



- Make regular stops to loosen up your limbs and refresh yourself, and avoid driving for hours on end.
- Keep a constant air circulation in the passenger compartment.
- Never coast downhill with the engine off: in these conditions the engine brake, servo brake and power steering are inefficient, braking requires greater pressure on the pedal and steering will be harder.

Driving at night

When you are travelling at night, follow these fundamental rules:

- Reduce speed, particularly on dark roads.
- Drive with due caution in consideration of the reduced visibility.
- If you start feeling tired or sleepy, stop immediately: to continue driving would be a risk for yourself and for others. Continue only after you have had a rest.
- At night, it is difficult to judge the speed of vehicles in front of you as you can only see their taillights: keep at a greater safety distance than you would during the day.
- Use the high beams only outside of urban areas and when you are sure that they will not disturb other drivers.
- Turn off the high beams when you see oncoming vehicles and use the low beams.
- Keep the lights and headlights clean.
- Watch out for animals crossing the road when travelling outside urban areas.

Driving in the rain

Rain and wet roads can cause hazardous situations.

All manoeuvres are more difficult on a wet road since tyres have significantly less grip on the road. This means that the braking distances increase considerably and road-holding decreases.

Below is some advice for driving in the rain:

- Keep a greater safety distance between yourself and the other vehicles and reduce your speed.
- When it is raining very hard, visibility is also reduced. In these cases, to make yourself more visible to others, turn on the low beams even during the day.
- Drive through puddles at low speed to avoid losing control of the vehicle (“aquaplaning”): if this occurs, grip the steering wheel firmly.

Warning



If the road is wet, reduce your speed to avoid “aquaplaning” (when the tyre no longer touches the road surface because the side channels of the tyre tread are not capable of removing all the channelled water due to their particular shape or insufficient depth and a layer of water is placed between the road surface and the tyre. The fluid pressure generated is so high that it supports the vehicle's weight making it virtually impossible for the driver to control the vehicle).



- Use the ventilation system to demist the windscreen (see page 169) and avoid visibility problems.
- Periodically check the condition of the windscreen wiper blades.

Driving in fog

Whenever possible, avoid travelling if there is thick fog. If you have to drive in misty conditions, or if there is thick fog or fog banks, follow these rules:

- Keep a moderate speed.
- Turn on the low beams, also during the day, and use the rear fog light. Avoid using the high beams.

Warning



On stretches where visibility is good, turn off the rear fog light, it may be annoying for the occupants of the vehicles behind you.

- Remember that fog makes the road damp and therefore all manoeuvres are more difficult and braking distances are longer.
- Keep a safe distance from the vehicle in front of you.
- As far as possible, avoid suddenly changing speed and direction.
- As far as possible, avoid overtaking.
- In the event of an emergency stop, (e.g. failures, inability to proceed due to poor visibility conditions, etc.) try to free the main driving lane. Then turn on the hazard warning lights and, if possible, the low beams. On approaching another vehicle, sound the horn rhythmically.

Driving on mountain roads

Below is some advice for driving on steep mountain roads:

- To prevent the brakes from overheating when driving downhill, use the engine to brake by engaging a lower gear.
- Never coast downhill or drive downhill with the engine off or in neutral, nor with the ignition key removed from the steering column.
- Drive at a moderate speeds and do not “cut” corners.
- Remember that overtaking uphill is slower and requires a longer free stretch of road. If you are overtaken when driving uphill, ensure that the other vehicle can pass easily.

Driving on snowy or icy roads

Below is some advice for driving in these conditions:

- Keep a very moderate speed.
- Keep a safe distance from the vehicles in front of you.
- Fit snow tyres approved for the vehicle.
- Given the poor grip, use the engine brake as much as possible and avoid sudden braking.
- Avoid sudden acceleration and sharp changes in direction.
- During the winter season, even apparently dry roads can have icy sections.

Therefore, be careful when driving along stretches of road in the shade as there may be icy patches.



Driving with the “ABS” braking system

The ABS system assists the driver as follows:

- It prevents the wheels from locking and skidding during emergency braking, particularly in low-grip conditions.
- It allows braking and changing direction at the same time. This feature is affected by the physical limits and lateral grip of the tyres.
- When the ABS is activated, you will feel a slight pulsing of the brake pedal during emergency braking or in low-grip conditions. DO NOT release the pedal but continue to push it to give continuity to the braking action.
- The ABS prevents the wheels from locking, but it does not increase the physical limits of grip between the tyres and the road: keep a safe distance from the vehicles ahead and reduce speed before curves.

Power steering system

The power steering system uses the power produced by the engine to help the driver steer more precisely while exerting less force on the steering wheel.

Important note



Remember that power steering does not work when the engine is switched off and more force is therefore needed when steering.

Warning



Do not keep the steering wheel fully turned (locked position) to the right or the left for more than 15 seconds when the engine is running. This may damage the power steering system.

Important note



If the power steering system is not working properly, as indicated by a symbol which appears on the left TFT display (see page 106), contact the FERRARI SERVICE NETWORK.



Suspension damping control

This vehicle uses latest generation MagneRide™ magnetorheological suspension, a system developed by Delphi and perfected by FERRARI for continuous automatic damping control.

By processing data received from the vehicle dynamics sensors and sensors that detect bodyshell movements, the ECU interprets the driving conditions and the road surface and immediately adjusts suspension response by varying the control current of each shock absorber.

These sensors allow the ECU to calculate the vehicle speed, vertical and lateral acceleration, steering angle and instantaneous pressure in the braking system, and hence to control suspension damping.

This system not only ensures an optimal compromise between racing-style performance (handling) and comfort, but is capable of emphasising either aspect by using the different adjustments available controlled by the “Manettino” driving mode control switch. Three different setting levels are available on this vehicle.

Level 1 (COMFORT)

Slightly more flexible setting, optimised to better absorb road unevenness and provide a better grip on wet road surfaces (Manettino set to WET).

Level 2 (SPORT)

Slightly more rigid adjustment optimised for sports-style driving and for high speed (with medium-high grip), without significantly affecting comfort (Manettino set to SPORT).

Level 3 (RACE)

Even stiffer setting optimised for occasional use on the race track (RACE, CT OFF and ESC OFF Manettino settings).

3



Driving using the driving mode control switch (“Manettino”)

The driving mode control switch on the steering wheel allows the driver to use the vehicle potential in a fast and intuitive way.

There are five modes available, which correspond to the grip level (from low to high) and consequently to the level of driving assistance required (from high to none).

WET mode

“WET” mode ensures stability on dry as well as on wet roads. It is therefore recommended for low grip conditions (e.g. rain) and on slippery or extremely uneven roads, but also to enhance comfort during city driving. Suspension damping is optimised to provide the best possible absorption (Level 1) and the ESC system is at its maximum level; the standard Bosch ASR system is activated instead of the F1-Trac function.

If “WET” mode is selected, it is indicated on the left TFT display as shown below:

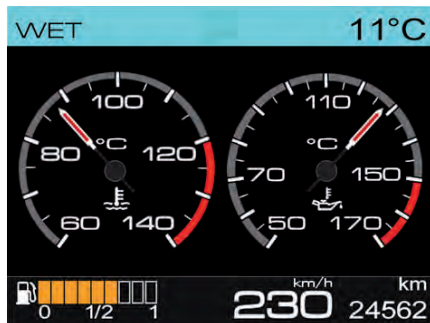

SPORT mode

The “SPORT” mode is the best setting for daily road use. This mode is designed to ensure stability only in medium-high grip conditions. Suspension damping shifts to Level 2 and gearshifting is more racy. The ESC system also switches to a different level offering you greater driving freedom.

If “SPORT” mode is selected, it is indicated on the left TFT display as shown below:





RACE mode

“RACE” mode is preferably for use on the race track, for the purpose of occasional testing. Gearshifting favours the racing style of the vehicle whereas the ESC system shifts to Level 3 (engine power reductions are minimal) and the suspension becomes even stiffer (Level 3). The performance ABS shifts to “Sport” level. This mode is designed to ensure stability on the race track in high grip conditions.

If “RACE” mode is selected, this is indicated on the left TFT display as shown below:



Warning



Test-driving the vehicle occasionally on the race track: after each start, cover the first straight stretch of the track (at least 500 meters / 0.3 mi) at a constant speed so that the traction control system and the ABS may calculate exactly the grip available and the diameter of the tyres (the calculation is reset every time the engine stops).

If this rule is not followed, system performance may be reduced.

3



CT OFF mode

In “CT OFF” mode the F1-Trac traction control is disabled. This mode further enhances the already racing -style behaviour of the vehicle: traction control is disabled while stability control remains active when a certain level of sideslip is exceeded. The gearshift mode, suspension damping and the performance ABS setting are the same as the previous position. The electronic differential has a specific setting developed to emphasise the dynamic qualities of the vehicle. Stability is not ensured.

If “CT OFF” mode is selected, this is indicated on the left TFT display as shown below:



ESC OFF mode

In “ESC OFF” mode the ESC system is disabled. No electronic systems other than the E-Diff control vehicle stability and the driver is allowed complete freedom and control of the vehicle for track use. The gearshift mode, suspension damping and the performance ABS setting are the same as the “RACE” and “CT OFF” modes.

Warning



In low- to medium-grip conditions (e.g. wet, icy, sandy roads), do not deactivate the **ESC** system.

Important note



Every time the engine is started, the **ESC** system will reactivate.

Important note



When the brake pedal is pressed, traction control is activated via the VDC system (vehicle dynamics control via the braking system).



If ESC OFF mode is selected, this is indicated on the left TFT display as shown below:

3





Suspension damping delink button

The driver may decide to separate the suspension setting from the logic of the “Manettino” driving mode control switch using the special button **A** on the steering wheel.

By pressing button **A**, irrespective of the position of the Manettino, the suspension setting shifts to Level 1 (COMFORT).

Position of Manettino	Suspension setting	Button A pressed
WET	COMFORT	remains COMFORT
SPORT	SPORT	shifts to COMFORT
RACE	RACE	shifts to COMFORT
CT OFF	RACE	shifts to COMFORT
ESC OFF	RACE	shifts to COMFORT



If button **A** has been pressed and subsequently the position of the Manettino is changed, the suspension setting follows the operating logic dictated by the Manettino.

Important note



Upon turning off and restarting the vehicle, the suspension setting depends on the position of the Manettino.

When the Manettino is set to SPORT, RACE, CT OFF or ESC OFF, shifting to the COMFORT suspension setting by pressing button **A** is indicated by displaying the special symbol and “Bumpy road” message on the left TFT display for 5 seconds.

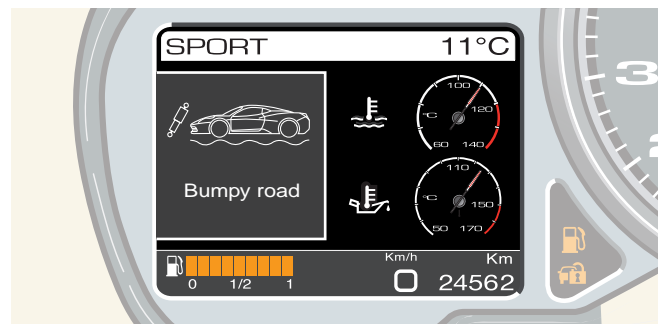



After 5 seconds, next to the Manettino status in the top of the display, the suspension symbol continues to be displayed as shown in the photo below (example shows Manettino in “SPORT” mode).

3

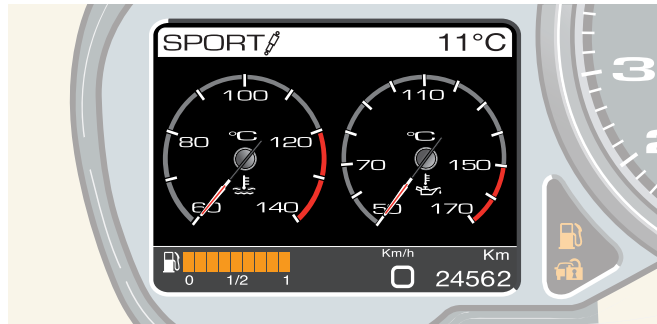



EPB - Electric parking brake

On this vehicle the parking brake is actuated by an electric motor. The parking brake can be applied and released by pulling a special lever **B** on the dashboard to the left of the steering wheel. With the ignition key turned to **II**, the relative indicator on the instrument panel (see page 108) lights up to indicate when the parking brake is engaged.

Pull the lever **B** while holding the brake pedal depressed to release the parking brake. If the ignition switch is turned to **II**, the indicator extinguishes once the parking brake is completely released.

The electric parking brake may be used as an emergency brake when the vehicle is in motion. If this is the case, the system acts on all four wheels until button **B** is released by communicating with the ESP system which prevents locking.

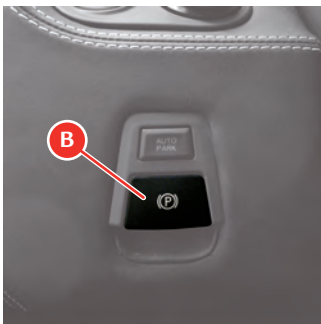

Warning



Always apply the parking brake when the vehicle is parked. The vehicle should be blocked. If this is not the case, please contact the **FERRARI SERVICE NETWORK**.

Drive Away function

The EPB electric parking brake also features a “Drive Away” function: if the driver engages a gear and presses the accelerator with the engine running and with the seat belt buckled, the system recognises the driver's intent to set off and automatically releases the parking brake.

EPB deactivation warning

If you try to deactivate the electric parking brake by moving lever **B** without depressing the brake pedal, the message “Depress brake pedal and deactivate EPB”, is immediately displayed on the left TFT display (even during system diagnosis, see page 129) accompanied by an acoustic signal.



Autopark Function

The EPB Autopark function automatically activates the electric parking brake when the engine is switched off. At each Key-on, the Autopark function is always active by default: this means that the driver does not need to apply the parking brake when the engine is switched off.

However, the function can be temporarily deactivated before switching off the engine by pressing the **AUTO PARK C** button: the message “PARK OFF” is displayed on the left TFT display for 5 seconds. In this case, after the engine is switched off, the parking brake must be engaged manually by pulling the lever **B**. To re-enable automatic EPB engagement at the next key-off, press the button **C** again; the message “PARK ON” is displayed on the left TFT display for 5 seconds.

“Automatic Vehicle Holding” AVH function

The Automatic Vehicle Holding function of the electric parking brake ensures optimised release when moving off from a standstill: after engine start, the system uses the service brakes to hold the vehicle instead of the parking brake shoes.

3





Park Lock

The Park Lock is a locking device built into the gearbox.

This device is used to prevent the vehicle from moving when the multi-disc clutches are open, i.e., with the engine off and/or without the hydraulic pressure required for gearbox operating.

The device operates automatically every time the key is turned to off: if a gear is engaged when the key is turned to off, the Park Lock is immediately activated. If the gearbox is in “N” (neutral), the Park Lock starts operating after a minimum preset time (needed for the Carwash procedure, see next paragraph). To inform the driver that the Park Lock has been engaged, the letter “P” is displayed on the gearbox display.

The Park Lock is deactivated when the engine is running, the first gear or “R” is requested (with the brake pedal pressed) and the luggage compartment lid has been closed correctly.

Carwash procedure

The Park lock device can be electrically disabled on a temporary basis when the engine is switched off by performing the Carwash procedure.

This procedure is necessary when the vehicle has to be moved with the engine off and when washing the vehicle.

Warning



When the Park Lock device is electronically deactivated (Carwash procedure), the vehicle may move. The vehicle is only kept stationary by the parking brake which must be applied.

To perform the Carwash procedure, do the following:

- with the engine running, select the first gear;
- select neutral “N”;
- switch off the engine;
- turn the key to position II (key-on) within 3 seconds of switching off.

The message “Carwash mode activation” will appear on the left TFT display.



Launch Control

The “Launch Control” mode is a performance start function. Activating this function optimises vehicle acceleration from a standing start.

The device, which is not available when the Manettino is set to the “WET” driving mode, transfers the necessary torque to the ground and avoids skidding of the wheels during acceleration.

To start the vehicle in “Launch Control” mode, do the following:

- the vehicle must be stationary
- the gearbox must be in “Manual” mode
- hold the brake pedal down and select first gear
- press the **LAUNCH L** button on the left of the centre console: an acoustic signal informs the driver that the device has been switched on and the word “launch” appears on the gearbox display
- press the accelerator pedal and release the brake pedal.



Important note



The “Launch Control” function is not available in presence of:

- a sloping road surface, even slight
- high clutch temperatures.

Warning



Only use the “Launch Control” function in appropriate traffic conditions and in optimum safety and road surface conditions.

3



Stop&Start system (optional)

Vehicles with optional HELE (High Emotion Low Emissions) technology are equipped with a Stop&Start system which automatically stops the engine when the vehicle is stationary and restarts it automatically when the driver wants to set off again.

The aim of the Stop&Start function is to increase vehicle efficiency by reducing CO₂ emissions especially when driving around town.

Automatic stopping and restarting of the engine is controlled by sensors and control strategies which, while reducing the impact on vehicle flexibility and comfort to a minimum, guarantee full operating of the safety systems and all the on-board systems even when the engine is switched off, without affecting climate comfort.

Warning



Never leave the vehicle without turning the ignition key to position **0**.

Always remember to remove the key from the ignition when you get out of the vehicle!

Never leave children unattended in the vehicle.

Warning



Make sure that the engine is switched off with the ignition key in position **0** before refuelling.

Warning



Always make sure that the Stop&Start system has been deactivated before carrying out any repair and/or maintenance work as indicated on the special labels in the engine compartment and underneath the vehicle.

Failure to comply with the above may pose a risk of serious injury to people working on the vehicle.

Warning



The driver is personally responsible for leaving the key in the ignition in position **II** when getting out of the vehicle: the driver must always turn the ignition key to position **0** before getting out of the vehicle.

Warning



Leaving the vehicle with the ignition key in position **II** puts those who are in the vicinity of the vehicle at serious risk if the engine starts unexpectedly.

Warning



Always turn the ignition key to position **0** before changing the tyres.



How the system works

If activated, the Stop&Start system decides when to switch off the engine and when to restart it according to the driving conditions, the climate comfort on board and the operating status of the vehicle. The system logic does not require drivers to make any change in the way they drive the vehicle.

Manual activation and deactivation button

The driver can activate/deactivate the Stop&Start system at any time by pressing button **A** on the roof panel. If the system is activated, pressing button **A** will deactivate it: the message “Stop&Start OFF” appears for 5 seconds on the left TFT display accompanied by a special symbol.

Once the system has been deactivated, pressing button **A** again reactivates the system: the message “Stop&Start ON” appears for 5 seconds on the left TFT display accompanied by a special symbol.

If the Stop&Start system is activated, the LED on button **A** comes on whereas if the system is deactivated, the LED goes off.

Deactivation of the system by pressing button **A** while in a stopped vehicle condition (when the engine has been automatically switched off by the Stop&Start function) automatically restarts the engine.

3

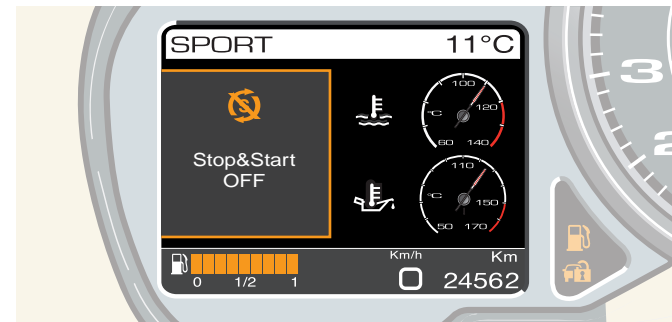



Important note



Each time the ignition key is turned to position II (Key-on), the Stop&Start system remains in the same state it was in when the switch was turned to position 0 (Key-off). If the function was activated at Key-off, it remains activated at the next Key-on and the LED on button A will flash for a few seconds.

Automatic engine stop mode

The engine stops automatically when the vehicle is stationary and the brake pedal is pressed, and restarts when the brake pedal is released.

The left TFT display informs the driver that the Stop&Start system has been activated by displaying the message “Stop&Start active” accompanied by a special symbol. The message is displayed as long as the vehicle remains in a stop state. To interrupt the display cycle and reduce the message to an icon, press the **MODE** button with “ESCAPE” function.

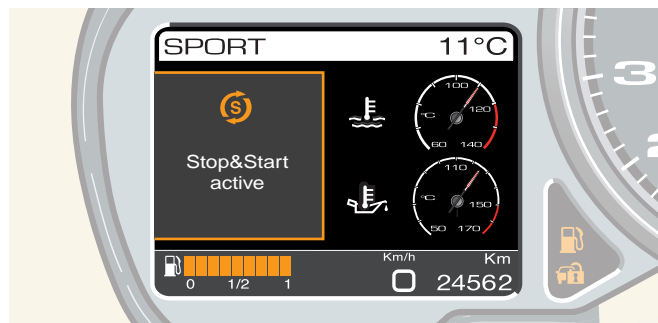
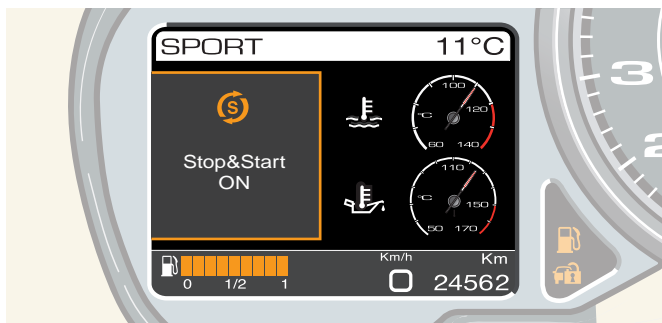



Conditions required to activate automatic engine stop

To activate the automatic engine stop while driving:

- **the Stop&Start system must be activated by pressing the button on the roof panel (LED on)**
- **the driver's seat belt must be fastened.**

For safety reasons and to guarantee driving comfort and correct operating of the entire vehicle, automatic engine switching-off is deactivated when:

- the accelerator pedal is depressed;
- a potentially dangerous situation is identified (steep road, vehicle stationary with wheels turned, i.e. when turning at a crossroads or on a roundabout);
- the system recognises vehicle motion in slow traffic or a parking manoeuvre (checking reverse gear engagement, time elapsed since last stop, driving speed);
- maximum air conditioning and heating system performance is requested ("low", "max defrost" or "rear screen demisting");
- external temperatures are very low or very high;
- the gearbox is in the "N" position;
- the Front Lift system has been activated;
- the DCT gearbox Park Lock has been manually released;
- a failure interferes with proper system operating.

The system also constantly monitors some of the vehicle operating parameters (battery charge level, engine coolant temperature, catalytic converter temperature, clutch oil temperature, vacuum level in brake servo, climate comfort in passenger compartment) so that engine switching off can be deactivated in certain conditions to guarantee safety and vehicle operating and minimise the impact on on-board climate comfort.

Important note



After the first cold start, the Stop&Start system may take a few minutes before it is ready. This time period allows some of the engine parameters (catalytic converter temperature, for example) to reach the values required to reduce emissions.

Important note



If the engine continues to run when the vehicle is stationary and the brake pedal is pressed, even if the Stop&Start system appears to be activated, it means that the system has disabled automatic switching off of the engine. When this happens, no specific signal is displayed on the instrument panel: this is to be considered normal.

3



Information on automatic restarting of engine

With the Stop&Start system activated in a stopped vehicle condition, the driver can restart the engine by:

- releasing the brake pedal
- **UP**-shifting
- engaging reverse gear
- pressing the accelerator pedal.

Warning



If the engine is switched off accidentally and not by the Stop&Start system, it must be restarted manually by the driver by pressing the **ENGINE START** button and reengaging the gear using the shift paddles located behind the steering wheel. This condition is indicated on the left TFT display by the message “Press **ENGINE START** button to restart”, accompanied by an acoustic signal.

For safety reasons and to guarantee comfort when the vehicle is stationary and correct operating of the entire vehicle, the Stop&Start system also automatically restarts the engine when:

- the **ENGINE START** button on the steering wheel has been pressed
- the function has been deactivated by pressing the button located on the roof panel
- the driver’s seat belt has been unfastened
- the driver-side door has been opened
- the Front Lift system has been activated
- rear screen demisting has been requested or the air conditioning and heating system set to “low” or “max defrost”.

The system also constantly monitors some of the vehicle operating parameters (battery charge level, engine coolant temperature, catalytic converter temperature, clutch oil temperature, vacuum level in brake servo, climate comfort in passenger compartment, vehicle speed) so that the engine can be automatically started in certain conditions to guarantee safety and vehicle operating and minimise the impact on on-board climate comfort.



Permanent deactivation of automatic restarting and manual start procedures

After automatically switching off the engine using the Stop&Start system, automatic restarting requested by the driver may not always be possible: this means that the vehicle systems have permanently deactivated automatic restarting.

If this occurs, the vehicle must be restarted manually: this condition is indicated on the TFT display by the message “Press ENGINE START button to restart”, accompanied by an acoustic signal.

Warning



If automatic restarting is permanently disabled, the vehicle behaves in the same way as a vehicle with no Stop&Start system: to restart, the driver must perform a manual start by pressing the **ENGINE START** button and using the shift paddles located behind the steering wheel.

Permanent deactivation of automatic restarting occurs when:

- the luggage compartment lid or engine compartment lid are open;
- automatic engine restarting has not been successful;
- a failure has been detected that may interfere with operating of the Stop&Start system.

At times, depending on the seriousness of the failure, the **ENGINE START** button may have to be held down for a few seconds to restart the engine: this condition is indicated on the left TFT display by the message “Press and hold ENGINE START button to start”.

3

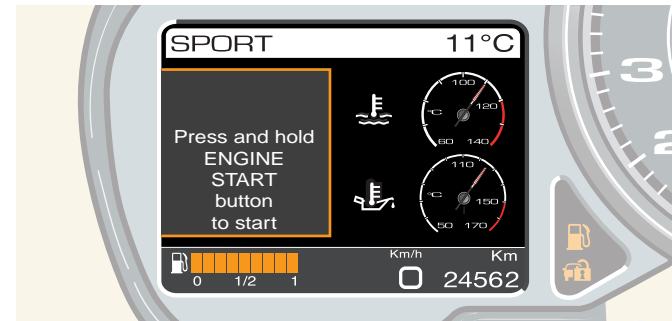
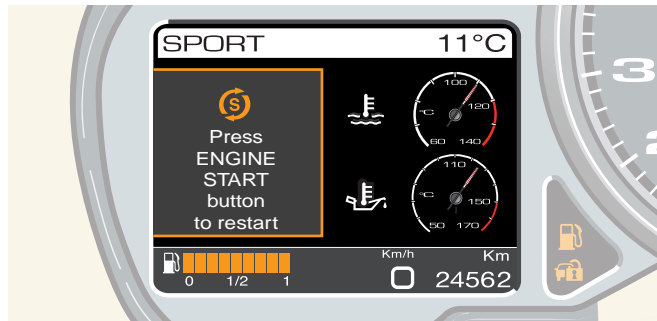



System failure

If malfunctioning, the Stop&Start system is disabled. The driver is informed of the failure by a special symbol that appears on the left TFT display for 20 seconds accompanied by an acoustic signal and the following message which corresponds to two different alarm levels:

- “Stop&Start failure” (orange symbol)
- “Stop&Start failure. Go to dealer” (red symbol).

Important note



Contact the **FERRARI SERVICE NETWORK** immediately.

When the display cycle ends (20 seconds), or the **MODE** button with “ESCAPE” function is pressed, the message disappears and the symbol is reduced to an icon.

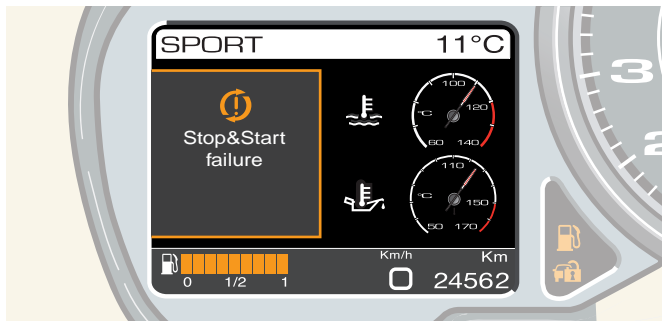

Precautions to be taken during maintenance work

Always turn the ignition key to position **0** before carrying out any repair and/or maintenance work on the vehicle. If work has to be carried out on the vehicle with the ignition key in position **II**, check that the Stop&Start has been deactivated by performing the following procedure before doing any repair and/or maintenance work:

if the ignition key is in position **II**, turn it to **0** before turning back to **II**, then press the Stop&Start system activation/deactivation button on the roof panel (see page 151). If the message “Stop&Start ON” appears on the left TFT display when the button is pressed, press the button again. Check that the message “Stop&Start OFF” appears on the left TFT display for 5 seconds. The button LED must be off.

Warning



NEVER work on the vehicle if the message “Stop&Start active” appears on the left TFT display.

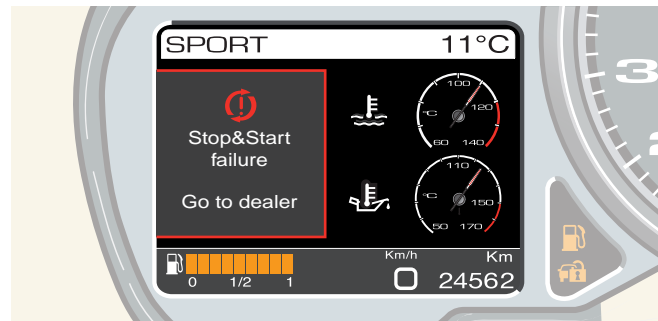



Dome light controls (HELE system only)

On vehicles with the optional HELE system, the central dome light **B** can be switched on or off by holding button **C** or **D** down (for more than 0.8 seconds).

The driver-side spotlight and the passenger-side spotlight can be switched on and off by pressing and quickly releasing buttons **C** and **D** respectively.



Disconnecting the battery (HELE system only)

On vehicles with the optional HELE system, the quick release **E** for disconnecting the battery from the electrical system (see page 198) is located on a dummy negative terminal in the bottom left of the battery compartment.

Warning



After disconnecting the battery from the electrical system, place clamp **E** between bracket **F** and the battery as shown so that it does not come into contact with the dummy negative battery terminal.

3

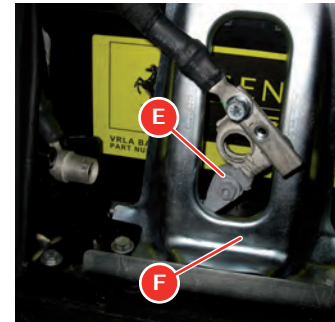
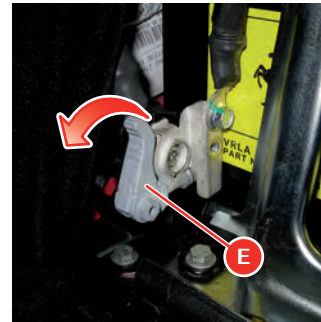



“Front Lift” system (optional)

On request, the vehicle can be fitted with a front suspension lift system: this device acts on the front suspension and raises the front of the car by approximately 40 mm (1.5 in.) to make access to garages or steep ramps easier and avoid damaging the car.

The system can be activated when the engine is running at a speed of below 40 km/h (25 mph) by pressing button **A** on the centre console. At speeds of over 40 km/h (25 mph), the system is deactivated whereas if it is already activated, it is automatically deactivated when exceeding 40 km/h.

Throughout the entire Front Lift system activation cycle, the special warning light (see page 108) remains on in flashing mode whereas the vehicle symbol with an arrow pointing upwards and a message “Front Lift moving” appears on the left TFT display. When the system has been activated (front of the vehicle raised), an acoustic signal is emitted and the message “Front Lift ON” appears for 5 seconds whereas the warning light on the panel stays on in fixed mode until the system is deactivated.

To deactivate the system, press button **A** again: at the start of the deactivation cycle, the warning light on the panel starts to flash again whereas the vehicle symbol with an arrow pointing downwards and the message “Front Lift moving” appears on the left TFT display. The message remains until the system has been completely deactivated.

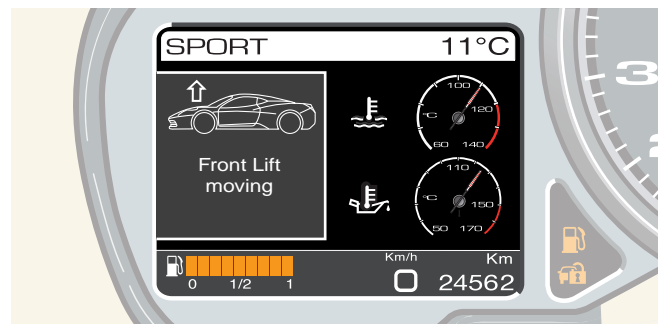



If the engine is turned off with the front suspension lift activated, the following message appears on the left TFT display at key-off: “LIFT ON. Set LIFT to OFF”. Turn the key back to position II (key-on) and press button **A** to lower the vehicle. If it is not manually deactivated by pressing the button, within 15 seconds of turning off the engine, the system is automatically deactivated.

Warning



The system has not been designed to remain activated when the engine is turned off and the vehicle is stationary. If the engine is turned off with the front lift activated, the vehicle is automatically lowered after 15 seconds.

Do not use the front suspension lift to park the vehicle on obstacles (e.g. pavements); these obstacles may come into contact with the front of the vehicle and damage it once the system has been deactivated.

In the event of engine failure, the “Front Lift” system can however be activated by pressing button **A** for 10 seconds. In this way, the vehicle front can be lifted even in emergencies when the engine is turned off (for example, to load it onto the ramp of a breakdown vehicle).

Important note



The front suspension lift should only be used for the purposes described above and not to drive over speed control systems (e.g. traffic calmers) more quickly.

3

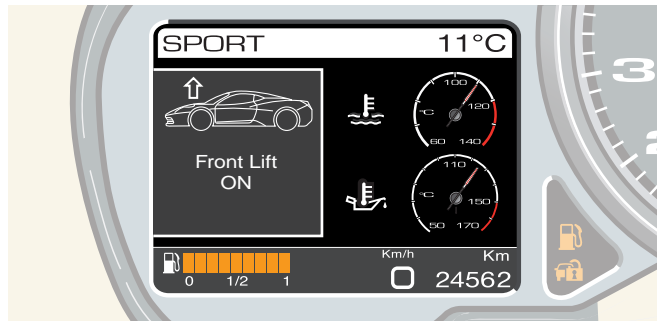



Seat adjustment

Warning



As with all adjustment, seat adjustment must be performed when the vehicle is stationary.

Super Racing seat

The seat position can be adjusted using the special controls.

Backward/forward adjustment

Pull lever **P** up and slide the seat forward or backward to the desired position. Release the lever and “wobble” in the seat to check that it is locked in place.



Warning



The backward/forward adjustment must consider the fact that airbag devices are placed in front of the driver and the passenger (see page 49).

Correct adjustment ensures there is adequate space between the airbag and the driver/passenger (see page 49).

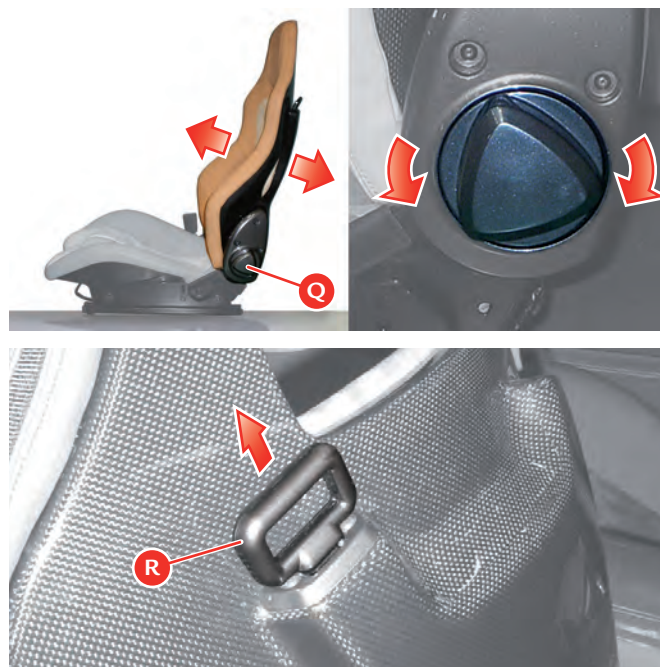



Seat back rake adjustment

Turn knob **Q** clockwise or counterclockwise until the desired back rake has been reached.

Tilting the backrest

Pull lever **R** up to tilt the backrest forward.

Adjusting the steering wheel

The steering wheel can be adjusted for rake and reach.

Warning



Do not adjust the steering wheel when the vehicle is moving.

Mechanical adjustment

- 1) Unlock lever **X** by pushing it forward.
- 2) Adjust the position of the steering wheel.
- 3) Lock the steering wheel by pulling lever **X** until it locks into place.

3





Rear-view mirrors

Internal rear-view mirror

Hold the internal rear-view mirror and move it to the required position.

On request, the internal rear-view mirror can be fitted with an electrochromic mirror that automatically darkens to reduce the dazzling effect of the reflected light on the driver. The speed with which the mirror darkens depends on the intensity of the light.

By pressing button **B** you can activate/deactivate the electrochromic mode. When the electrochromic mode is activated, the green LED **D** comes on.



External rear-view mirrors

These mirrors can be electrically adjusted using the control **C** (with the ignition key in position **II**) and are equipped with defogging elements.

- 1) Mirror selection: turn control **C** to the left or right lock position to select the mirror that requires adjusting.
- 2) Mirror positioning: move control **C** in the four directions (up – down – right – left) to adjust the selected mirror.
- 3) Mirror closure (optional): turn control **C** to the lower central lock position to close the rear-view mirrors.

Once adjusted, move the control **C** into the upper central position where it will be locked in order to avoid changing the external mirror setting inadvertently.

The mirrors will yield in both directions in the event of a collision: if necessary, the mirrors can be pushed both backwards and forwards.

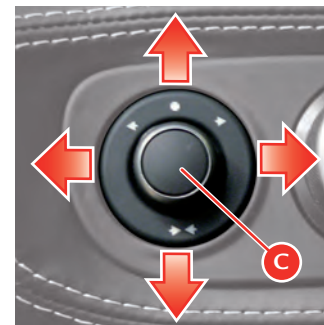
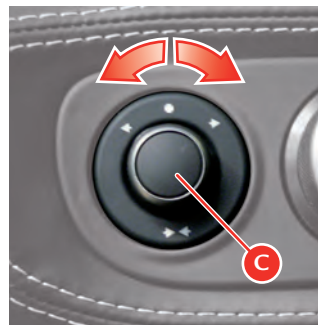



Warning



The rear-view mirrors must always be positioned correctly while driving.

Do not adjust the rear-view mirrors when the vehicle is moving.

On request, the external rear-view mirrors can be fitted with an electrochromic mirror.

3



Air conditioning and heating system

Operating modes

Automatic

This mode automatically adjusts the air distribution, temperature and ventilation levels according to the temperature set by the user.

Partially Automatic

This mode allows the user to adjust certain parameters manually, while others remain automatic.

Manual

This mode allows the user to set the values to suit the passengers' needs.

Controls

- 1 Left-hand temperature setting and **AUTO** button
- 2 A.C. compressor activation/deactivation
- 3 Single-zone mode activation/deactivation
- 4 Air distribution fan speed
- 5 Rear view mirrors demist activation/deactivation
- 6 Windscreen demist activation/deactivation
- 7 Right-hand temperature setting and **AUTO** button
- 8 Right-hand air distribution mode setting
- 9 Air recirculation
- 10 Left-hand air distribution mode setting.

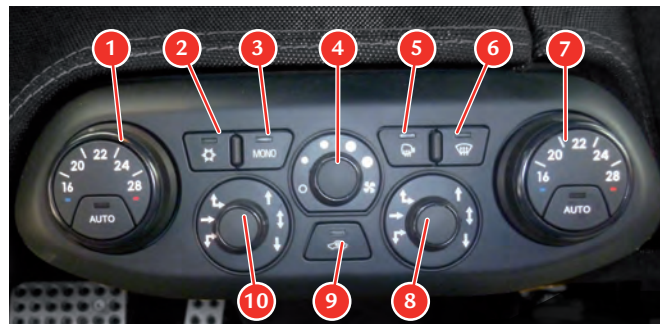



Left-hand temperature setting and AUTO button (1)

This is used to select the required air temperature in the left-hand side of the passenger compartment; the **AUTO** button is used to activate automatic operation (LED on).

A.C. compressor activation/deactivation (2)

This is used to activate (LED on) or deactivate (LED off) the A.C. compressor.

Single-zone mode activation/deactivation (3)

This is used to activate (LED on) or deactivate (LED off) the single-zone operating mode.

Air distribution fan speed (4)

The four setting positions allow the occupants to select the air flow rate.

Rear view mirrors demist activation/deactivation (5)

Press (LED on) to activate rear view mirrors defogging/demisting.

Windscreen demist activation/deactivation (6)

Press this button (LED on) to activate windscreen defogging/demisting.

3

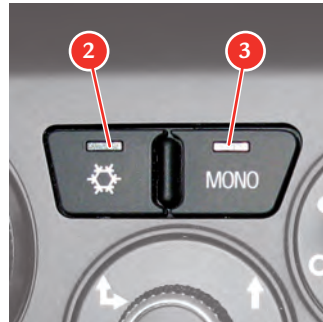



Right-hand temperature setting and AUTO button (7)

This is used to select the required air temperature in the right-hand side of the passenger compartment; the AUTO button is used to activate automatic operation (LED on).

Right-hand air distribution mode setting (8)

This is used to select one of the six air flow distribution modes in the right-hand side of the passenger compartment.

Air recirculation (9)

If released (LED off), the air flow comes from outside the passenger compartment.

When outside temperatures exceed 32 °C (90 °F), the air recirculation feature remains on with a 60-second pause every twenty minutes to refresh the air.

If you activate the windscreen washer function, the air recirculation feature activates for 20 seconds, to prevent any smell of detergent products from entering the passenger compartment.

If pressed (LED on), the air flow comes from inside the passenger compartment.

The recirculation increases air heating or cooling.

Left-hand air distribution mode setting (10)

This is used to select one of the six air flow distribution modes in the left-hand side of the passenger compartment.

Once the internal temperature has stabilised at the desired level, you are advised not to change the position of the temperature selection switch unless the external temperature changes drastically.

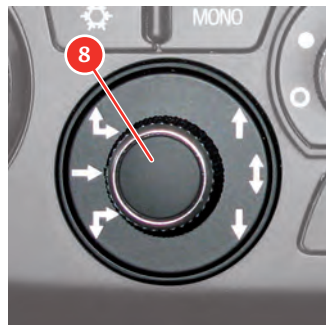



Maintenance

The pollen filter must be replaced every year, as indicated in the “Maintenance Schedule”.

Important note



The air coming out of the vents does not correspond to the temperature requested by the user, but is the temperature required to maintain the desired temperature inside the passenger compartment.

Important note



We recommend keeping the air flow set to open and directing the air flow to a neutral position.

3

Adjusting the air vents

The adjustable air vents are positioned on the sides and in the central section of the dashboard.

Use control **A** to direct the air flow.

Use control **B** to adjust the air flow rate.

Turned to left: closed.

Turned to right: open.

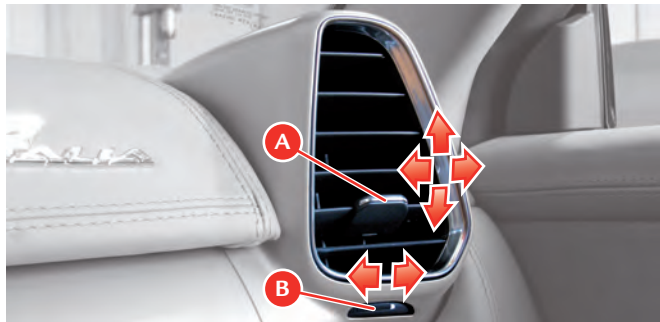



Passenger compartment accessories

Knee guard

This is located on the passenger side of the dashboard, and protects the lower limbs of the occupants in the case of a collision or emergency braking.



Pocket-change compartments

They are located on the lower part of the doors and on the centre console.

There is also a cup holder in the front of the centre console.

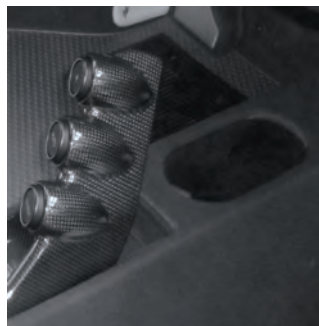



Sun visors

The sun visors can be moved by pulling them down towards the windscreen and sideways by unhooking them from the fastener and turning them towards the door glass.



12V power socket

The power socket **D** on the centre console can be used to power small electrical appliances such as mobile phones, lights, vacuum cleaner and any other accessory with absorption not exceeding 140 Watts and a voltage of no more than 12 Volts.

Warning



Prolonged use of this device may discharge the battery.

Do not try to insert plugs into the power socket that are not the right size and shape.

3

Warning



Use the power socket to connect the tyre repair and inflation kit in an emergency **ONLY** for the amount of time strictly necessary.

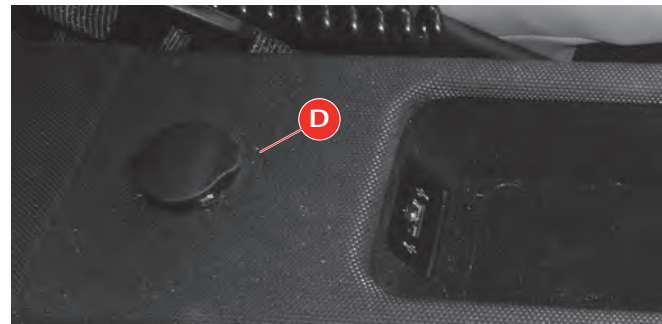

Toolkit	174
Replacing light bulbs	179
Replacing a fuse	182
Replacing a wheel	190
Towing.....	192
Battery.....	194
Battery conditioner.....	198
EPB emergency release.....	202
Park Lock emergency release	204



ADVICE FOR EMERGENCY SITUATIONS



Warning



Repair work using the toolkit requires:

- suitable protective equipment (e.g. gloves);
- adequate precautions to be taken (e.g. during tyre replacement never lie under a vehicle raised by a jack);
- minimum specific expertise when working in contact with electrical parts/components (e.g. battery).

Toolkit

Tool bag

Stored in the luggage compartment, it contains the necessary tools for emergency repair jobs:

- pair of cotton gloves;
- set of fuses;
- pliers for removing fuses;
- tow hook;
- Allen key;
- funnel for emergency fuelling;
- screwdriver for slotted and crosshead screws;
- EPB emergency release tool;
- Park Lock emergency release tool.





Warning



The Electric Parking Brake (EPB) emergency release tool and the Park Lock emergency release tool may only be used by specialised workshop personnel, as indicated on the label in the tool bag.

Warning



The Electric Parking Brake (EPB) emergency release tool is flexible and is kept folded up in the tool bag; remove the tool from its housing very carefully to prevent the end flying out.

4



Emergency tyre repair and inflation kit

Stored in the luggage compartment, it can be used in the event of a puncture or low tyre pressure to repair and/or inflate a tyre enough to continue the journey safely.

Important note



To use the tyre repair and inflation kit correctly, refer to the instruction booklet supplied with the kit.

Warning



Give the instruction manual supplied with the kit to the personnel that will handle the tyre repaired with the tyre repair kit.

Warning



In the event of a puncture caused by foreign objects, tyres can be repaired with cuts of up to **4 mm** in diameter on the tyre tread and shoulder.

Warning



Punctures cannot be repaired on the sides of the tyre. Do not use the tyre repair kit if the tyre has been damaged after driving with a flat tyre.

Warning



Damage to the wheel rim that causes air leaks cannot be repaired. Do not remove foreign objects (screws or nails) that have penetrated the tyre.

Warning



After using the repair kit, the vehicle must be considered in an emergency situation: drive with the greatest care (maximum permissible speed 80 km/h - 50 mph).

Warning



Apply the sticker supplied with the kit where it can easily be seen by the driver to indicate that the tyre has been treated with the tyre repair kit.

Drive carefully especially on bends.

Avoid sudden accelerations or braking.

Warning



The kit is to be used to temporarily repair only one tyre punctured by small objects: the kit may not be useful in the case of large punctures or tearing.



Important note



After driving for approximately 10 minutes, stop and recheck the tyre pressure.
Remember to apply the parking brake.

Warning



If the pressure has decreased below **1.8 bar** (26.11 psi), do not continue driving: the kit cannot guarantee the correct hold because the tyre is too damaged. Contact the FERRARI SERVICE NETWORK.

If the tyre pressure is at least **1.8 bar** (26.11 psi), restore the correct pressure and continue driving.

Drive very carefully to the nearest FERRARI SERVICE NETWORK.

Warning



The repaired tyre must be replaced as soon as possible and the workshop personnel must be informed that the tyre was treated with tyre repair fluid.

Warning



Keep the kit in its box and out of children's reach.
Do not inhale or swallow the fluid contained in the cartridge and avoid contact with the skin and eyes.

Warning



The spray contains ethylene glycol and latex.
The latex may cause an allergic reaction, is harmful if swallowed and is irritating to eyes. May cause sensitisation by inhalation and skin contact. Avoid contact with eyes, skin and clothing. In case of contact, rinse immediately with plenty of water. If swallowed, do not induce vomiting, rinse mouth, drink plenty of water and seek immediate medical advice. Keep out of reach of children. The product should not be used by asthma sufferers. Do not inhale vapours during use. In the event of an allergic reaction, seek immediate medical advice. Store the spray can in its special case away from sources of heat.
The liquid sealant has an expiry date: the expiry date is indicated on the kit.

4



Environment



Replace the spray containing the expired liquid sealant. Do not dispose of the spray can and sealant in normal domestic waste. Dispose of in accordance with national and local regulations or ask the **FERRARI SERVICE NETWORK** to take care of disposal.

Warning



The sealant in the kit cartridge can damage the sensor inside the wheel rim on vehicles fitted with a tyre temperature and pressure monitoring system (TPMS).

If this occurs, the sensor must be replaced. Contact the **FERRARI SERVICE NETWORK**.

Warning



Wear the protective gloves supplied with the tyre inflation and repair kit.

Useful accessories

In addition to the tools supplied with the vehicle, the hazard warning triangle and fluorescent safety jacket should always be kept on board in order to signal hazardous situations in compliance with regulations.



Replacing the front and rear light bulbs

Important note



To replace the front and rear light bulbs, contact the **FERRARI SERVICE NETWORK**.

To adjust the headlight beam, please contact the **FERRARI SERVICE NETWORK**.

Replacing number plate light bulbs

To replace a number plate light bulb, proceed as follows:

- remove the light from the right side where there is a spring clip;
- remove the transparent cover **A** from its housing;
- replace the bulb by removing connector **B** from its housing;
- refit the connector and transparent cover by inserting it first from the left side and then pressing on the other side.

4

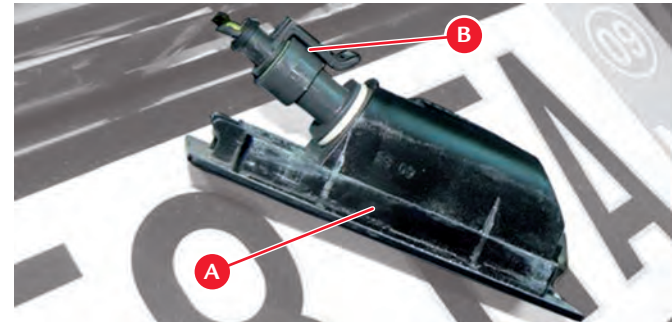



Replacing other light bulbs

Roof dome light

- Use a screwdriver to gently prise under the edge of the transparent cover **C** of the dome light and remove it from the roof panel.
- Replace the bulb **D** or **E** or **F**.
- Refit the dome light and make sure that the wires are not trapped by inserting it first from the connector side and then pressing on the opposite side.

Underdoor and luggage compartment lights

- Prise gently under the edge of the transparent cover with a screwdriver and lift the cover.
- Completely remove the transparent cover from its housing.
- Take the bulb out of its clips.
- Replace the bulb.
- Refit the transparent cover and make sure that the wires are not trapped by inserting it first from the connector side and then pressing on the opposite side.

Follow the same procedure for replacing the underdoor light bulbs and the luggage compartment dome light bulb.

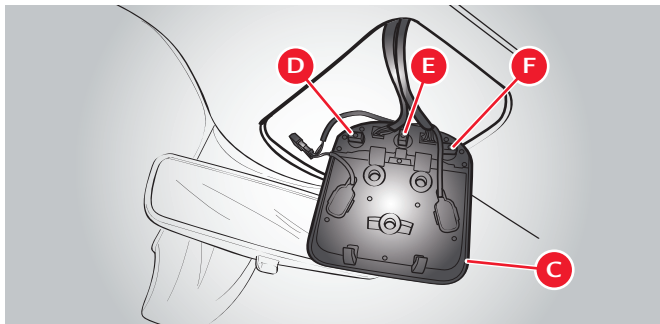



Light bulbs (12 V except for high beam and low beam)

	Type	Power
Low beams and high beams	gas-discharge (XENON)	Das
Front running lights	LED	
Front turn indicator lights	LED	
Side turn indicator lights	incandescent	T4W
Running and stop lights	LED	
Reverse lights	incandescent	H6W
Supplementary stop lights	LED	
Rear turn indicator lights	LED	
Rear fog lights	incandescent	H21W
Number plate lights	incandescent	5W
Passenger compartment dome light	incandescent	8W
Spotlights	incandescent	5W
Underdoor courtesy lights	incandescent	5W
Luggage compartment lights	incandescent	5W

4



Replacing a fuse

When an electrical device is not working, check that the corresponding fuse is not blown.

A - Unblown fuse.

B - Blown fuse.

Important note



If the problem persists, contact the **FERRARI SERVICE NETWORK**.

Important note



When replacing a fuse, always use fuses of the same amperage (same colour).

The tool bag contains spare fuses.

To remove the fuses, use the pliers **C** in the tool bag.

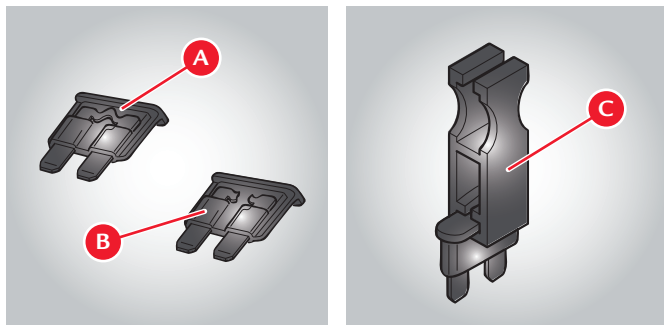

Fuse colours

	Ampere
yellow ochre	5
brown	7.5
red	10
light blue	15
yellow	20
white	25
green	30

Maxi fuse colours

	Ampere
yellow	20
green	30
orange	46
red	50
blue	60



Location of the fuse and relay boxes

- A** - Fuses and relays in battery compartment
- B** - Body Computer fuses and relays
- C** - Fuses and relays in passenger compartment on passenger side
- D** - Fuses and relays on driver-side rear side panel

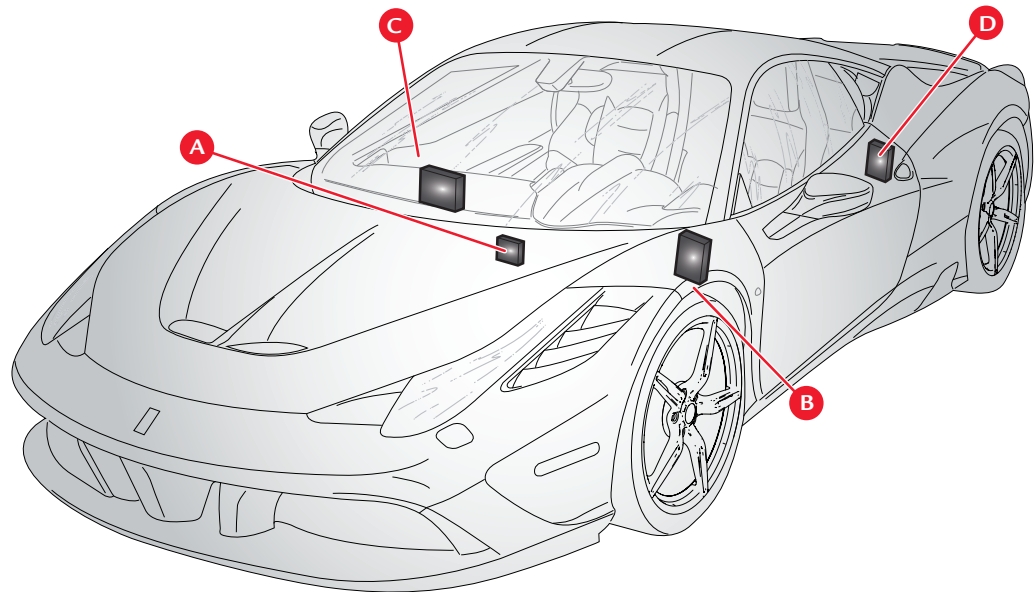

4



Fuses and relays in battery compartment

To access these fuses, remove the cover of the box **A** situated above the positive terminal on the right hand side of the battery.

Important note



Only open the boxes containing the fuses that need to be checked to avoid damaging other components.

Box **A** contains these fuses:

Ref.	Amp.	Use
CAL5	CAL5	Power supply (starter motor and alternator)
F-70	150	Engine relay and fuse ECU power supply (SCM)
F-71	50	Front lift pump

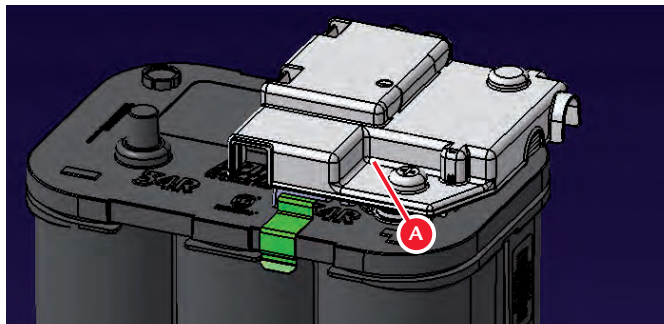

F-73 70 Dashboard ECU power

Body Computer fuses and relays

To access these fuses, remove the dashboard panel **1**.

Important note



Only open the boxes containing the fuses that need to be checked to avoid damaging other components.





Box **B** contains these fuses and relays:

Ref.	Amp.	Use
F-12	15	Right high beam
F-13	15	Left high beam
F-31	7.5	INT/A for dashboard ECU and Body Computer Node relay coils
F-32	10	Dome lights, foot well and step lights, Side Marker relay coil
F-34	30	Right hand Brembo EPB system motor
F-35	7.5	Stop light control, clutch control, air conditioning node
F-36	10	Volumetric anti-theft system, parking sensors, fuel filler flap relay coil
F-37	10	Stop light control, Instrument Panel Node, Suspension Control Node
F-38	15	Luggage compartment lock actuator

F-39	15	Dashboard ECU devices (NBC interconnection)
F-42	15	USB charging socket
F-43	30	Windscreen washer/wiper relay power supply
F-47	30	Driver-side door, driver-side power window
F-48	30	Passenger-side door, passenger-side power window
F-49	7.5	Rain and twilight sensor, parking sensors, parking brake control, column adjustment control, hazard warning lights, Steering Wheel Node, Differential Control Node, radio, CAN box interface
F-50	7.5	Airbag Node, weight sensor
F-51	7.5	Semi-automatic Gearbox Node
F44	20	Cigarette lighter

4

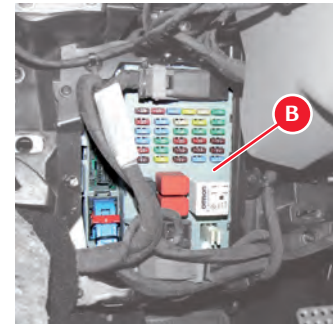
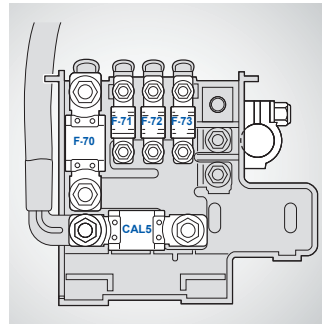



F-33	30	Left hand Brembo EPB system motor
F-53	10	Instrument Panel Node power supply
T01	20	Low beam relay
T11	30	Heated rear window relay
T12	30	Service relay 1 (dependent on INT/A ignition switch)
T13	50	Jumper (service power supply 2)

Fuses and relays in passenger compartment on passenger side

These fuses are located behind the knee guard **2**.

Boxes **C** contain these fuses and relays:

Ref.	Amp.	Use
F-01	40	Right hand radiator fan relay
F-02	30	F97, F98 protection fuses for ABS
F-04	50	+30 ABS (pump)
F-05	40	+30 Air conditioning Node
F-06	40	Left hand radiator fan relay
F-07	20	+30 Horn relay
F-08	7.5	Air conditioning and heating system compressor
F-09	7.5	+30 Supplementary stop light relay (third stop light)





F-10	15	Tyre pressure monitoring system + DRL ECU
F-11	25	Left bank oxygen sensor
F-14	10	+30 High beam relay
F-15	10	+30 Power supply for EPB-activated stop light control relay, right headlight LED module power supply relay
F-16	25	+30 Right bank engine control power supply
F-17	25	+30 Left bank engine control power supply
F-18	10	+30 Left cylinder bank injection system power supply, LH cylinder bank injection main relay coil
F-19	10	+30 Right cylinder bank injection system power supply
F-20	30	+30 Right cylinder bank injection system main relay
F-21	30	+30 Ignition switch protection
F-22	15	Left bank (ignition coil)
F-23	30	Suspension Control Node
F-24	15	Right bank (ignition coil)
F-30	30	
F-81	50	Fuel pump ECU
F-82	70	+30 Dashboard ECU and ECU on driver-side rear side panel power supply
F-83	50	+30 Air pump relay

F-84	30	Protection for fuses F94 F95 F96
F-85	25	Headlight washer
F-87	25	Right bank oxygen sensors
F-88	10	+15 Left cylinder bank injection system
F-89	10	+15 Right cylinder bank injection system
F-91	10	Left hand cylinder bank sensors
F-92	10	Right hand cylinder bank sensors
F-93	7.5	Ionising engine ECU
F-94	15	+30 Radio/CAN box/ICP/clock spring/Japan navigation system stabiliser
F-95	10	+30 Current stabiliser
F-97	30	ABS hydraulics
T02	30	High beam relay
T03	30	

4





F96	7.5	+15 ignition switch, stabilised for buttons
F98	10	ABS electronics
T05	30	
T06	30	
T07	50	Horn relay
T08	30	Air conditioning and heating system compressor relay
T09	30	Left cylinder bank injection system main relay
T10	30	Right cylinder bank injection system main relay
T14	30	
T17	10/20	INT/A relay (devices excluded at ignition)
T19	30	EPB-activated stop light control relay
T20	30	

T26	10/20	Windscreen wiper first speed relay
T27	10/20	Windscreen wiper second speed relay
T28	30	Windscreen washer pump relay
T29	30	Supplementary stop light relay (third stop light)
T30	50	Air pump relay
T31	30	Headlight washer pump relay
T37	30	+15 stabilised power for button backlighting
T38	30	Left headlight LED module power supply relay
T39	30	Right headlight LED module power supply relay
T40	30	Start enable relay

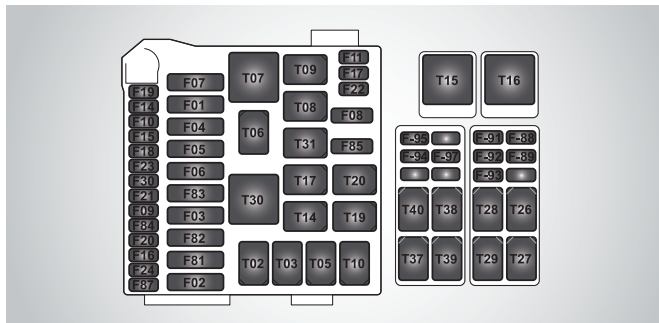



Fuses and relays on driver-side rear side panel

To access these fuses, remove the driver-side rear side panel **3**.

Boxes **D** contain these fuses and relays:

Ref.	Amp.	Use
F-54	15	+30 Gearbox cooling fan
F-56	30	
F-57	7.5	Side Markers 1 (LH front and RH rear)
F-59	7.5	Reverse light power supply
F-60	30	Active aerodynamics
F-61	7.5	+30 Driver Position Node (electronic), front lift
F-62	7.5	
F-63	20	+30 Semi-automatic gearbox main relay
F-64	7.5	Fuel filler flap actuator power supply

F-65	20	+30 Door lock actuator
F-66	7.5	+30 Semi-automatic Gearbox Node
F-67	7.5	Side Markers 2 (RH front and LH rear)
F-78	15	+30 Battery charger
F-80	30	+30 Starting relay
T21	50	Side Marker relay
T22	30	Reverse light relay
T23	30	Fuel filler flap relay
T24	30	Gearbox cooling fan relay
T25	30	Semi-automatic gearbox main relay
R1		Starter power relay
R2		Starter power relay

4

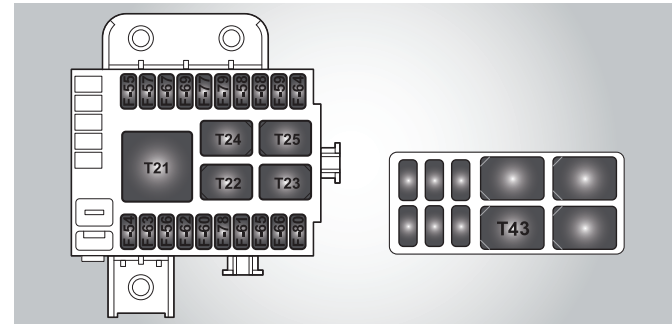
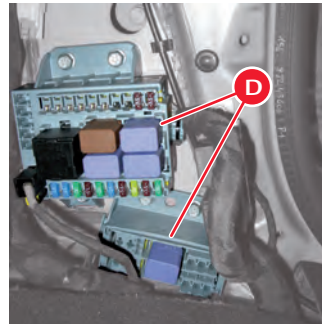
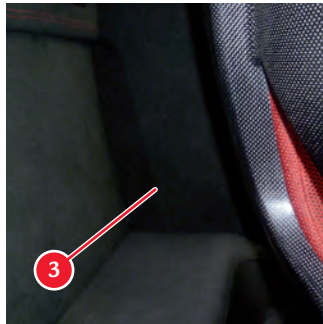



Replacing a wheel

Important note



If one or more wheels need to be replaced, proceed as follows:

- replace the wheel stud bolts with damaged threads or tapers
- carefully clean the wheel stud bolts before fitting
- do not lubricate the contact surfaces between the stud bolt and the wheel rim and between the wheel rim and the brake disk.

In order not to remove the antilock coating, do not clean the wheel rim cones with solvents or aggressive products.

Collapsible spare wheel (optional)

On request, the vehicle comes with a kit containing:

- collapsible spare wheel **A** with space-saving tyre; label **B** indicates the maximum speed allowed of 80 km/h (50 mph);

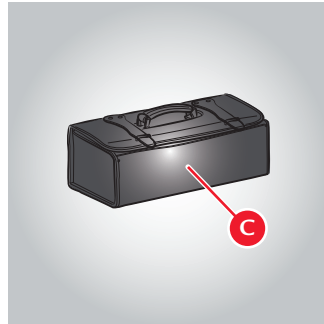
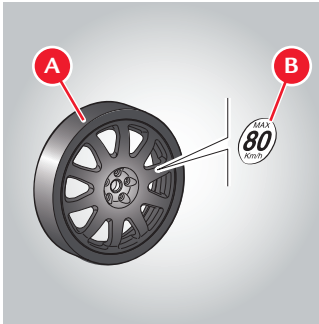

- additional tool bag **C** containing the jack for raising the vehicle and the socket wrenches for operating the jack and tightening the wheel stud bolts.

Warning



The spare wheel must only be used for short trips in the event of an emergency.

When the spare wheel is fitted, never exceed the maximum speed of 80 km/h (50 mph) and drive carefully, especially around bends and when overtaking, avoiding sudden acceleration or braking.

Do not exceed the approved weight limits.

Do not fit snow chains on the spare wheel.

Never fit more than one spare wheel at a time.

Important note



Failure to comply with these instructions could lead to loss of control of the vehicle and consequently damage to the vehicle and injuries to its occupants.



Replacing a wheel

- Position the vehicle on an even surface, then block the rear wheels by applying the parking brake.

Warning



Make sure that the vehicle is in a safe position by applying the parking brake.

- If necessary, switch on the hazard warning lights and place the hazard triangle at the required distance from the vehicle.
- Take the spare wheel and tools out of the luggage compartment.
- Loosen the five wheel stud bolts approximately one turn each using wrench **D** supplied.
- Place the base of the jack **E** on flat firm ground under one of the jacking points **F** on the underfloor as shown in the figure.

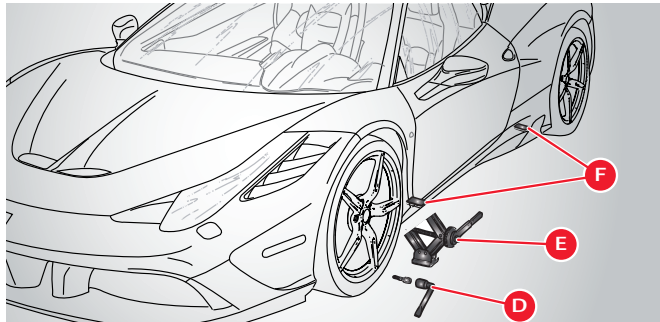

- Raise the vehicle carefully using jack **E** until the wheel is off the ground.

Warning



If the jack is not positioned correctly, the vehicle could slip off.

Make sure that no part of the body is underneath the vehicle while changing the wheel.

The supplied jack must only be used for changing wheels.

- Unscrew the five stud bolts and remove the wheel.
- Fit the uninflated collapsible spare wheel.
- Screw the stud bolts into place but do not tighten them.

Warning



Inflate the collapsible spare wheel before lowering the vehicle to avoid damaging the rims.

- Inflate the collapsible spare wheel using the inflation kit.

4



Warning



The kit must be used in “tyre inflation” mode. Refer to the instruction manual supplied with the kit.

- Inflate the spare wheel to the indicated pressure (see page 29).
- Lower the vehicle and remove the jack.
- Tightly fasten the stud bolts, alternately going from one stud bolt to one that is diametrically opposite.

As soon as possible, tighten the stud bolts with the torque wrench to a torque of 100 Nm.

Warning



The space saver spare wheel does not have a tyre pressure monitoring sensor (see label on spare wheel tool bag). After fitting, it is not checked by the system but complies with international regulations ECE R64/01.

After fitting, we recommend that you go to the nearest FERRARI SERVICE NETWORK.

Towing

When towing the vehicle, avoid using anchor points that are not designed for tow hook **A** inserted in housing **C**.

Proceed as follows:

- Take tow hook **A** out of the tool bag.
- Screw the tow eye **A** fully into the threaded hole **C** in the front bumper.
- Release the EPB.
- Release the Park Lock.

Warning



In the event of an electrical system failure, release the EPB and Park Lock manually (see pages 202-204).

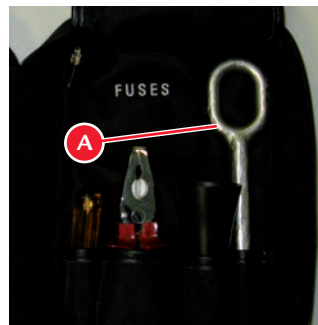



Warning



While towing the vehicle, you must comply with Road Regulations.

Warning



Do not tow the vehicle by attaching to levers, suspension and wheel rims but only to the tow hook properly fitted in place. Keep the key in position II to enable the lights to work and prevent the steering wheel from locking if it is turned; when towing the vehicle, do not start the engine.

Important note



Remember that when the engine is switched off, the power steering and brake servo functions do not work.

Fuel inertia switch

The fuel inertia switch is a safety device which deactivates the fuel pump relays if a collision occurs.

A symbol appears on the left TFT display and the hazard warning lights come on to indicate that the switch has been activated.

When the fuel inertia switch is activated, the doors are also unlocked (if locked) and the central dome light comes on.

Warning



The fuel pump relays can be reactivated by pressing the button in the battery compartment which can be accessed by opening the passenger side footrest.

4





Battery

The battery is located in the passenger compartment behind the passenger side footrest.

Checking the battery

Warning



The battery does not need topping up with distilled water or sulphuric acid.

Warning



The battery must only be removed from the vehicle by the **FERRARI SERVICE NETWORK**.

Warning



Do not place the battery near sources of heat, sparks or naked flames.

The vehicle is equipped with a sealed lead acid battery that does not require maintenance.

- Periodically check that the terminals and pins are clean and firmly secured.
- Visually inspect the outer casing for any cracks.
- If the battery overcharges, it will wear out quickly. Have the vehicle electrical system checked if the battery tends to discharge easily.

Disconnecting the battery

Before disconnecting the battery, deactivate the electronic alarm using the remote control.

Warning



Never disconnect the battery from the electrical system when the engine is running.

Before disconnecting the battery, lower the side windows by at least 2-3 centimetres (0.8-1.2. in.) to avoid damaging the strips when opening and closing the doors.

Warning



When the battery is connected and charged, this operation is automatically performed when the doors are opened and closed. The windows must remain lowered until the charged battery is reconnected. If the battery is discharged and the windows are fully up, only open the doors when strictly necessary and take great care; do not close them again until the windows can be lowered.

Important note



We recommend using the battery conditioner if the vehicle is going to left unused for a long period.

To cut off the power supply from the battery to the electrical system, use the quick release **C** terminal on the left hand side of the battery. Use the locking lever to loosen the terminal.



Detach the terminal from the battery. In this way, the power supply from the battery to the electrical system is cut off.

Warning



The battery quick release connector may only be used by qualified personnel, should it not be possible to connect the battery conditioner.

The battery is an integral component of the vehicle, and required the vehicle itself to be used frequently in order to function correctly. Infrequent vehicle usage may reduce battery performance or result in complete battery failure.

Constant usage of the specific battery conditioner provided by FERRARI for each model ensures that the original battery installed in the vehicle is kept charged correctly and in working order.

Warning



Place the terminal so that it does not come into contact with the battery terminal or other metal parts of the vehicle.



Reconnecting the battery

Place the clamp on the battery and fasten it by closing the locking lever.

Each time the battery is reconnected, do the following before starting the engine:

- close both doors and close the luggage compartment lid; unlock and lock the doors using the remote control; open the luggage compartment lid using the remote control;
- adjust the clock (date and time on instrument panel);
- close both doors and fully raise the driver side and passenger side windows to their upper limit; check that the windows move down to the “target position” when the doors are opened.

Warning



Before starting the engine, wait at least 60 seconds with the ignition key in position II to allow the electronic system that controls the motor-driven valves and the AC ECU to run a self-acquisition process.

During this period, no devices must be activated.

The Motronic ECU self-acquisition cycle will only function correctly when the intake air temperature is above 5 °C (41 °F).

After removing the battery from the vehicle or disconnecting it from the electrical system using the battery master switch, it is important to check that the external temperature is within the indicated values when reconnecting before performing the self-acquisition cycle.

4



Emergency starting

If the battery is flat, you can perform an emergency start by connecting the special jump leads to the battery of another vehicle, a portable jump starter or an external battery.

Important note



Emergency starting can only be performed with batteries with a nominal voltage of 12 V.

Important note



For emergency starting, only use leads that do not allow reverse polarity, with sufficient cross-section and insulated clamps.

To perform an emergency start, do the following:

- Apply the parking brake.
- Deactivate all the electrical devices.
- Remove cover **A** of the fuse box located above the positive terminal on the right side of the battery.
- If emergency starting is performed using the battery of another vehicle, leave the engine on the other vehicle to idle.
- Using the jump leads, connect the positive terminal of the battery to the positive terminal of the portable jump starter or external battery going from the battery on your own vehicle.
- Connect the negative terminal of the portable jump starter or external battery to an earthing point on your vehicle using the jump lead going from the external battery.
- Start the engine.
- Disconnect the jump lead from the earthing point and then from the positive terminal of the battery on your vehicle.

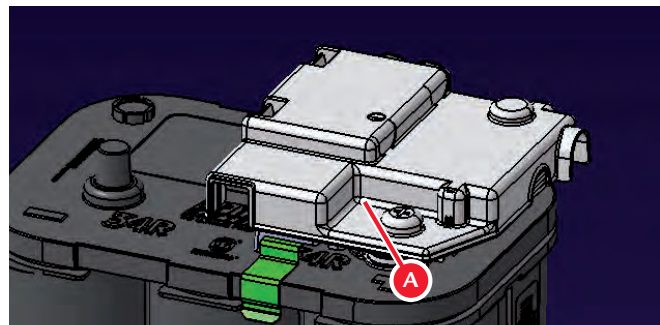



Warning



The emergency start procedure must only be performed by a specialised FERRARI SERVICE NETWORK centre.

4



Battery conditioner

The vehicle is equipped with a battery conditioner to maintain and recharge the battery.

Important note



Leaving the battery discharged for prolonged periods may cause battery malfunction or reduced battery performance.

Using the battery conditioner will extend the life of the battery (see page 223).

The device is kept in a pocket inside the car cover bag supplied with the vehicle.

The socket for the battery conditioner is situated under the passenger side of the dashboard.



Warning



Place the battery conditioner where it can be easily seen away from heat sources and out of children's reach.

After connecting the battery conditioner to the socket in the vehicle, pass the connector cable under the front of the passenger side door.

Important note



Do not run the connection cable out of the vehicle in positions other than those indicated to prevent damaging the seals and/or the cable.

If you do not plan to use the vehicle for over a week, we recommend you connect the battery conditioner to keep the battery in perfect working order.





Warning



The engine cannot be started as long as the battery conditioner is connected to the vehicle socket.

Important note



Additional technical information on the use of the device can be found in the manual provided inside the pocket of the car cover bag.

Exhaust system overheating alarm devices (“Slow Down” function)

If the engine is running unevenly resulting in exhaust system overheating, the “Slow Down” function is activated: a special symbol (see page 106) appears on the left TFT display accompanied by a message.

The message varies according to three alarm levels:

- **Temperature high:** “Catalysts temp. high. Slow down”.
- **Temperature too high:** “Catalysts temp. too high. Engine performance limited”.
- **Catalytic converter temperature system failure:** “Catalysts temp. not plausible. Go to dealer slowly”.

Displaying of the message is controlled by the thermistor via the engine control ECU.

4

Warning



Incorrect use of the vehicle may cause the “Slow Down” function to be activated.

Warning



If the temperature is **high**:
slow down immediately so that the exhaust system temperature decreases.



Warning



If the temperature is **too high**:

the temperature in the catalytic converters has reached a dangerous level and could damage them; if you continue to drive, the engine control ECU intervenes and reduces the torque produced by the engine.

The torque limit remains active until the catalytic converter temperature goes down to normal operating values.

Warning



If catalytic converter temperature system failure information is displayed:

- the engine control ECU intervenes and reduces the torque produced by the engine
- the driver must slow down and slowly drive to the nearest FERRARI SERVICE NETWORK to have the engine parameters checked.

Warning



If the EOBD warning light (see page 105) comes on at the same time as the “Slow Down” message, go to the nearest FERRARI SERVICE NETWORK to have the ECU error memory checked. Do not proceed in any other way.

Clutch overheat alarm devices

Extremely high performance use of the vehicle at high engine speeds for prolonged periods and at high ambient temperatures may cause the DCT gearbox clutches to overheat. In this case, the following safety warnings will be displayed on the left TFT display, corresponding to two different alarm levels:

- The message “Clutch overheated”
- The message “Clutch overheated” accompanied by an acoustic signal.

When the message “Clutch overheated” is displayed, the driver may notice a difference in the behaviour of the system during gearshifts and/or during standing starts.

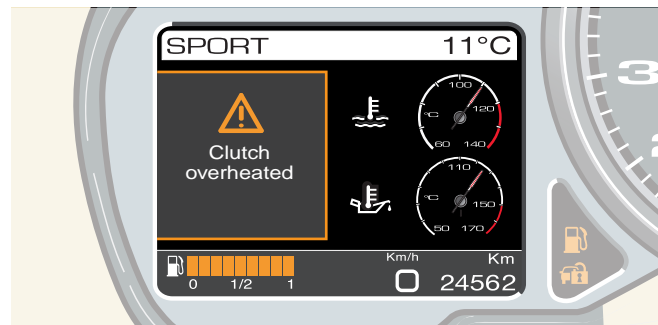



Important note



Certain high-performance actions (including but not limited to: “LAUNCH” control start, standing start with wheelspin with Manettino set to ESC OFF, etc.) may be inhibited to prevent excessive overheating of the clutches: the system warns the driver that the action is not permitted by displaying the message “Operation not admissible” on the left TFT display.

Warning



As soon as any of the warnings described above appear on the left TFT display, the driver must slow down, continue driving at an engine speed between 2000 and 3000 rpm and minimise gearshift frequency to allow the clutches to cool down as quickly as possible. These driving conditions must be maintained until the message “Clutch overheated” is no longer displayed.

Engine malfunction alarm devices

If the “**engine control system failure**” (EOBD, see page 105) warning light flashes or comes on permanently while the engine is running, it indicates that the engine or the emission control system may be malfunctioning.

The electronic system detects and isolates the error preventing damage to the engine or the production of harmful emissions.

Warning



When the “engine diagnostic system failure” warning light comes on, engine performance may be considerably reduced. Drive carefully, avoiding sudden acceleration and high speeds. Contact the **FERRARI SERVICE NETWORK** immediately.

4



Replacing the brake pads and discs

Brake pads

The front brake pads have a wear detector connected to the brake warning light; if this warning light comes on or braking is not even, have the pad thickness and the state of the braking surfaces checked.

The minimum brake pad thickness is 3 mm - 0.12 in. (thickness of the friction material only).

Replacing brake pads

When the brake failure warning light comes on, it means that the front brake pads are excessively worn and must be replaced immediately.

Warning



To guarantee the quality of the components and proper installation, we recommend that you have the brake pads replaced at a **FERRARI SERVICE CENTRE**.

After replacement, avoid sudden braking until the new pads are seated properly (approximately 300 km - 186 mi).

Emergency release of the electric parking brake (EPB)

Warning



The release procedure must only be carried out by specialised workshop technicians and with the vehicle switched off.

If the system cannot be released, contact the nearest **FERRARI SERVICE CENTRE**.

Warning



When the electric parking brake is deactivated manually, the vehicle may move.

To keep the vehicle stationary, the Park Lock safety device must be applied: make sure that the letter “**P**” appears on the gearbox display.

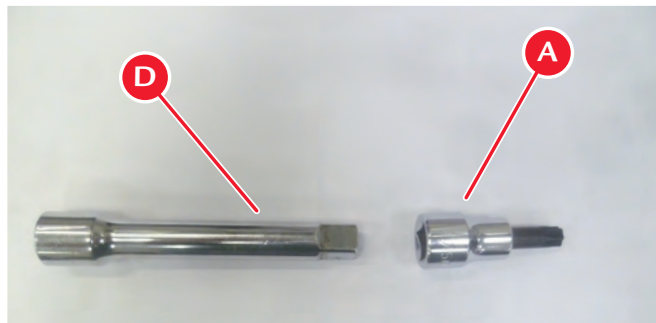



If the electric parking brake cannot be deactivated because the battery is flat or there is a failure in the electrical system controlling it, and the vehicle needs to be moved, the emergency release procedure described below must be performed.

- Before performing this procedure, remove fuse F33 and F34 from the body computer fuse box, situated under the driver side of the dashboard (see pages 184 -186).
- Select the EPB emergency release socket wrench **A** from the tool bag and connect to the extension **D**.

Warning



The EPB emergency release tool **A** may only be used by specialised workshop technicians, as indicated on label **C** on the tool bag.

- The EPB system components are situated over the right and left hand rear callipers: insert the EPB release tool **A**, connected to the extension **D**, through the access holes **B**. Insert a standard 1/2" wrench from the opposite end of the extension **D** and turn anticlockwise by two turns to free the brake discs.

Warning



Never loosen the screws completely.

Once the electric parking brake has been manually released, the EPB node records a failure at the next key-on and a special symbol and the following message are displayed on the left TFT display: "Parking Brake system revision. Go to dealer".

Warning



If access to the screws is obstructed by a wheel spoke, the wheel must be removed.

The EPB release procedure is irreversible and compromises the functionality of the parking brake.

Take the vehicle to an authorised service centre to have the parking brake reset correctly and cancel any errors from the fault memory.

Go to a FERRARI SERVICE CENTRE.

For safety reasons, the reset procedure is mandatory.

4

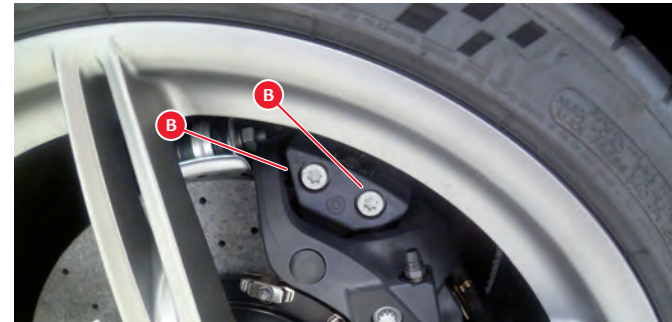



Park Lock emergency release

Warning



The emergency release procedure must only be carried out by specialised workshop technicians.

If the system cannot be released, contact the nearest FERRARI SERVICE CENTRE.

Warning



This should be avoided unless absolutely necessary:

- to tow the vehicle;
- if there is a Park Lock failure (displayed on the left TFT display with the message “Only manual unlock gearbox allowed: See handbook”).



Warning



When the Park Lock safety device is deactivated manually, the vehicle may move unexpectedly.

The vehicle is only kept stationary by the parking brake, if applied.

The Park Lock manual emergency release device is found in the engine compartment, in line with the gearbox next to the filter housing, as shown by the arrow in the figure.

To perform the Park Lock emergency release procedure, do the following:

- Take wrench **D** out of the tool bag.

Warning



Wrench **D** may only be used by specialised workshop technicians, as indicated on label **C** on the tool bag.

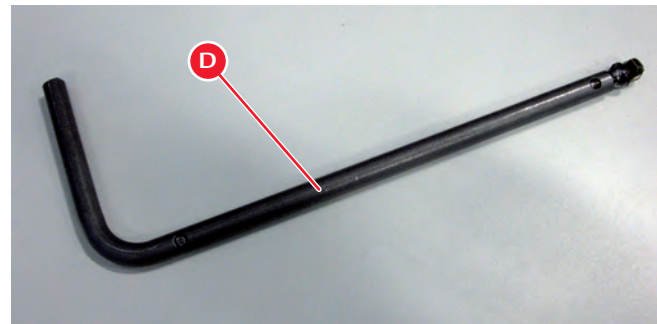



- Open the engine compartment lid.
- Extend wrench **D** and place it in the manual release device housing keeping it bent so that it can reach the housing.

Important note



Make sure that notch of wrench **D** fits onto pin in the housing of the device.

- Once the wrench has been placed in the housing, lightly press down on the filter housing to bring to wrench at right angles to the housing.
- To perform the emergency release, turn wrench **D** counterclockwise for a quarter turn.

If the electrical system allows it, check that the letter “N” appears on the gearbox display by turning the ignition key to position **II**. The following message will appear on the left TFT display: “Gearbox not in Parking position”. At the same time, an audible signal is repeated four times to indicate that it has been released.

4

Warranty Booklet	208
Maintenance	208
Level checks.....	210
Wheels and tyres	217
Maintenance of seat belts and pretensioners.....	219
Cleaning the vehicle	219
If the vehicle is stored for long periods	223



5



CARE OF THE VEHICLE



Warranty Booklet

The vehicle comes with a “Warranty Booklet”.

This contains the vehicle’s warranty validity conditions.

Maintenance

It is essential to always keep the vehicle in proper working order to ensure a long working life and to prevent any running defects, caused by negligence or lack of maintenance, and consequently to avoid hazardous situations.

Important note



All repair work on any safety system component must be performed by the FERRARI SERVICE NETWORK. See the chapter on safety, page 37.

Maintenance schedule

At the intervals prescribed, the FERRARI SERVICE CENTRES must perform all the fine-tuning and checking operations indicated in the “Warranty Booklet”.

It is however advisable to report any small fault which occurs when using the vehicle (e.g. small leaks of essential fluids) to the FERRARI

SERVICE NETWORK immediately and not wait until the next service is due to correct the problem.

Periodic maintenance services must be performed at least once a year even if the specified mileage limit has not been reached (see “Yearly Maintenance” in the “Warranty Booklet”).

Displaying information on scheduled maintenance

If the next scheduled maintenance deadline is approaching, at key-on, the message “Service Stop within:” is displayed for 5 seconds on the left TFT display followed by the number of kilometres or days before vehicle servicing. The information is provided in kilometres or days according to the deadline that comes first.

Information on scheduled maintenance can also be displayed on the left TFT display if requested by the driver irrespective of the scheduled deadlines. To do this, call up the MENU screen page (see page 86) and select “Service”.

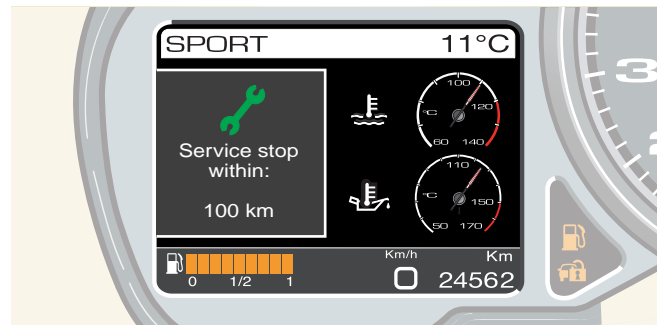



Chassis and bodywork maintenance

The chassis has technological and manufacturing specifications that require that any operation be performed by staff specially trained to work with this innovative technology.

It is of crucial importance to use equipment tested by FERRARI if the repair work is to be performed in accordance with rules of good workmanship. Proper execution of repair work ensures that the commercial value of the vehicle is preserved and the safety standards are complied with.

Important note



If the chassis is damaged in an accident, FERRARI advises customers to contact the FERRARI SERVICE NETWORK who will perform the necessary safety checks.

The chassis, under standard conditions of use, requires no maintenance; it is however advisable to contact the FERRARI SERVICE NETWORK at the intervals indicated in the “Warranty Booklet” in order to have it checked.



Level checks

Ref.		Page	Ref.		Page
A	Engine oil tank cap	212	D	Brake fluid tank cap	215
B	Coolant tank cap	214	E	Windscreen/headlight washer fluid tank cap	216
C	Power steering oil tank cap	214			

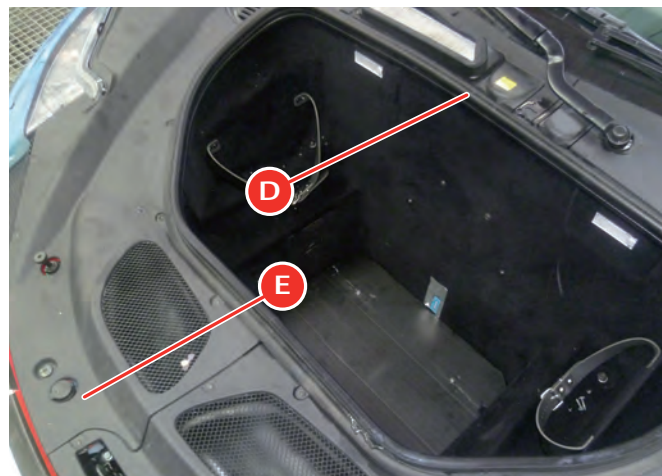
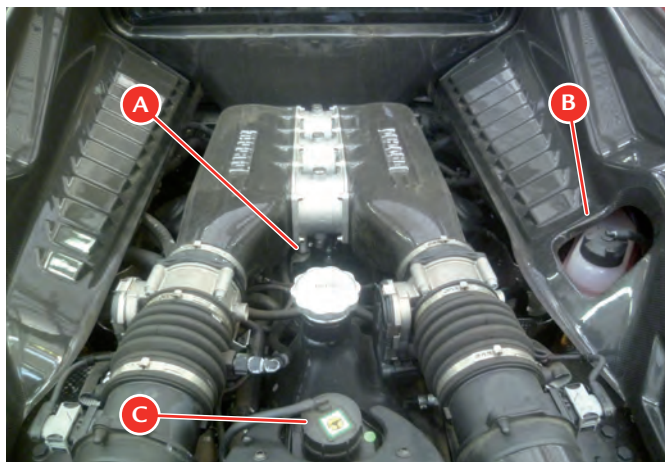



Important note



The level checks must be performed at the intervals indicated in the “Warranty Booklet” or, in any case, before starting a long journey.

Environment



All the materials used for the following operations (e.g. cloths soaked with oil or grease, pans, etc.) must be disposed of in compliance with the environmental protection regulations.

Important note



Only use lubricants and/or fluids recommended by FERRARI (see the “Refilling” table on page 34).

5



Checking the engine oil level

Warning



The engine oil level must be checked when the engine is idling and warm and the vehicle is on level ground.

DO NOT add oil with different characteristics from those of the oil already in the engine.

The symbol, shown below, on the left TFT display and the message “Check engine oil level” inform the driver that the engine oil level must be checked.



Proceed as follows:

1. Run the engine to reach an engine oil temperature of 90 °C (194 °F).
2. Leave the engine running at idle speed.
3. Wait 2 minutes and then open the engine compartment lid and unscrew the oil tank cap **A**.
4. Clean the dipstick on the cap.
5. Place the cap **A** on the tank filler neck, with the cap spring in its seat as shown in detail **M**.
6. Remove the cap and check that the level is between the **MIN** and **MAX** notches on the dipstick.

Important note



The distance between the **MIN** and **MAX** notches corresponds to approximately 2 litres of oil.

7. Top up if necessary with the recommended oil, taking care not to fill beyond the **MAX** level on the dipstick;

Warning



If the oil level is below **MIN**, top it up and then have the system checked by the **FERRARI SERVICE NETWORK**.

8. Screw the cap back on tightly.





After topping up, the “low oil level” symbol on the left TFT display may remain on for some time. This will allow the system to perform all the necessary checks. You should therefore consider this behaviour normal.

9. When you have added or changed the oil, check the oil level once again as indicated above.

Environment



Top up with due care to avoid pouring the oil out of the filler neck.

Checking the DCT gearbox oil level

Important note



We recommend that you have the oil level of the DCT gearbox checked by the **FERRARI SERVICE NETWORK** or by skilled staff.

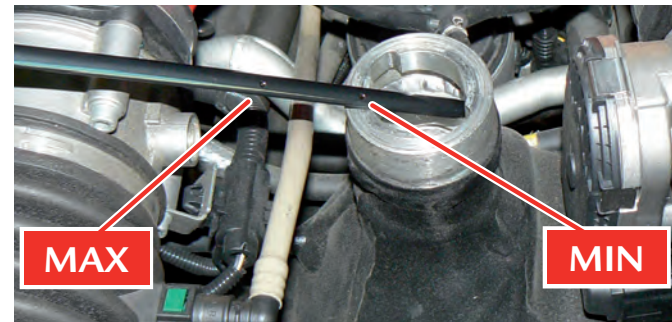
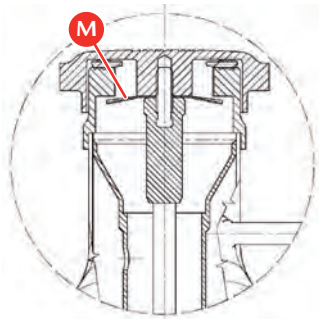

5



Checking the coolant level

Warning



The coolant in the cooling system reaches very high temperatures and pressures. This procedure must always be performed when the **ENGINE IS COLD**. Never remove the cap from the expansion tank when the engine is running or warm.

- Check that the level comes up to the dotted line shown in the figure.
- If the level is low, remove the cap **B** from the expansion tank and top up with the recommended coolant.

Important note



If frequent top-ups are required after short trips, have the system checked by the **FERRARI SERVICE NETWORK**.

- Screw the cap **B** back on tightly.



Checking the power steering system oil level

Warning



The power steering oil level must be checked with the engine warm, after having driven at least 15 km (9 mi). If it is checked when the engine is cold, the level may appear to be very low even when the recommended amount of oil is in the system.

Warning



If the oil level is below **MIN**, top it up and then have the system checked by the **FERRARI SERVICE NETWORK**.

Proceed as follows:

- Remove cap **C** with the dipstick from the tank





- Check that the power steering oil level is between the **MIN** and **MAX** levels on the dipstick.
- If the level is near the **MIN** reference mark, top up with the recommended oil up to the **MAX** level.

Warning



Always use the indicated quantity of new, recommended fluid taken from sealed containers.

The fluid in the circuit is synthetic. The use of mineral-based fluid may irreparably damage the rubber system gaskets.

- Screw the cap **C** back on tightly.

Environment



Do not dispose of used fluid in the environment.

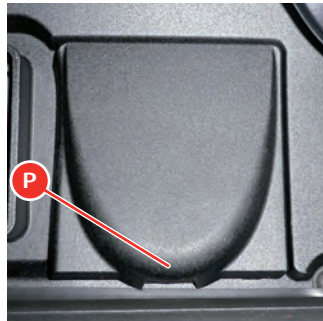
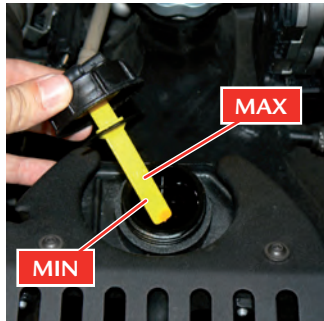

Checking the brake fluid level

The brake fluid tank is located under the right-hand under-windscreen protective cover. Proceed as follows:

- Remove cover **P**, remove cap **D** and check that the fluid is near the **MAX** mark shown in the figure.

Important note



Clean cap **D** before removing it

- If the level is near the **MIN** mark shown in the figure, top up with the recommended oil to the **MAX** mark.

Warning



Always use the indicated quantity of new, recommended fluid taken from sealed containers.

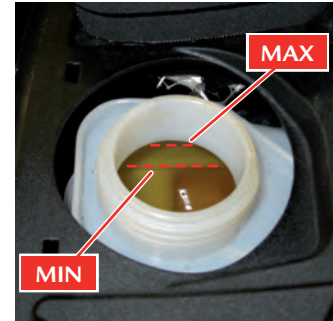

5



Environment



Never dispose of used fluid in the environment.

Warning



The fluid in the brake system may damage plastic, rubber and painted parts and is highly dangerous if it comes into contact with the eyes or the skin.

If the fluid comes into contact with the eyes or skin, wash the affected part thoroughly with running water. To avoid any risk, always use protective goggles and gloves.

Keep out from children's reach!

Warning



The use of mineral-based fluids will irreparably damage the system rubber gaskets.

Do not use fluids other than those already in the system for topping up.

- Screw cap **D** back on tightly.

Windscreen and headlight washer fluid

The windscreen and headlight washer fluid tank can be accessed by lifting the luggage compartment lid.

- Lift the cap **E** and fill the tank with the recommended fluid (see the “Refilling” table on page 34) until it can be seen in the fluid filling manifold.
- Close cap **E**.

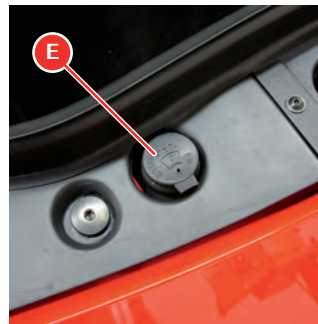



Wheels and tyres

To ensure maximum performance and tyre life and to permit the best tyre adjustment on the wheel rim, it is important to comply with the following instructions for the first 200/300 km (125 - 185 mi) with new tyres:

- avoid sudden acceleration
- avoid sharp braking and steering
- drive at moderate speed on straight roads and on curves.

How to use the tyres

Important note



To ensure safe driving, the tyres must be kept in good condition.

The inflation pressure must correspond to the specified values and must be checked only when the tyres are cold since tyre pressure increases as tyre temperature increases.

Never reduce the pressure if the tyres are hot.

Environment



Periodically check the tyre pressure. Driving with the tyres inflated to the correct pressure helps to reduce fuel consumption.

Low tyre pressure can lead to overheating, internal damage and even destruction of the tyres.

Warning



Inflating the tyres to a pressure other than the specified value will render the TPMS monitoring system ineffective.

Sudden impact with pavements, potholes and other obstacles of various types as well as long trips on rough roads can cause damage to the tyres that is not always visible to the naked eye.

Check the tyres regularly for any signs of damage (e.g. scratches, cuts, cracks, bulges, etc.).

If sharp objects penetrate the tyres, they can cause damage which is only visible when the tyre is removed.

Have any damage inspected by an expert as it may considerably reduce tyre life.

Remember that tyres deteriorate over time even if they are rarely used or not used at all.

Cracks in the tread and side walls, possibly accompanied by bulging, are sure signs of ageing.

5



Warning



The FERRARI SERVICE NETWORK is suitably equipped to replace tyres, and to determine whether a tyre is safe for use.

Have the tyres replaced by the FERRARI SERVICE NETWORK that has the necessary equipment available to avoid causing damage through carelessness to the sensor located inside the wheel rim (on vehicles with the tyre temperature and pressure monitoring system - TPMS).

Important note



The FERRARI SERVICE NETWORK can certify whether aged tyres are suitable for use.

Warning



Replace the tyres at intervals no longer than 4 years of normal usage, even if the maximum mileage specified has not been exceeded.

Never fit tyres of uncertain origin.

Warning



The tyres are of the “directional” type and there is an arrow marked on their side wall to indicate the direction in which they must rotate or which side is the outer side. When replaced, maximum performance levels can only be ensured if the rotation direction corresponds with the direction indicated by the arrow.

Tyres on the same axle must always be replaced in pairs.

Regularly check the tyre tread (minimum acceptable depth **1.7 mm**). As the tread wear increases, there is a greater risk of skidding.

Warning



Drive carefully on wet roads to reduce the risk of “aquaplaning”.

Wheel alignment check and adjustment

When you notice unusual wear of the tyres and in any case, at the intervals prescribed in the “Warranty Booklet”, have the FERRARI SERVICE NETWORK check the wheel toe-in and camber.



Maintenance of seat belts and pretensioners

- Periodically check that the screws on the anchor points are tight and that the seat belt is in perfect condition and slides smoothly.
- The seat belt must be kept clean; the presence of any dirt could prevent the seat belt retractor from working properly.
- To clean the seat belt, wash it by hand with mild soap and water, rinse it and let it dry. Do not use strong detergents, bleach or aggressive solvents, as they can weaken the fibres.
- Do not let the seat belt retractors get wet: proper functioning is only ensured if they are kept dry.
- The pretensioner requires no maintenance or lubrication. If immersed in water or mud, the pretensioner must necessarily be replaced.
- The pretensioner must be replaced at the intervals indicated in the “Warranty Booklet”.

Cleaning the vehicle

Cleaning the exterior

Environment



All the materials used for the following operations (e.g. cloths soaked with oil or grease, pans, etc.) must be disposed of in compliance with the environmental protection regulations.

Proper care of the vehicle on the part of the owner is essential for the vehicle long life.

Here is a list of the main precautions to be taken.

- Certain parts of the vehicle should not be left wet or dirty for long periods of time: in particular, the passenger compartment floor and the luggage compartment must always be kept clean and dry. The draining holes under the doors should be kept unclogged to allow any water to drain.
- The underbody and the lower surfaces of the vehicle should be cleaned regularly, and more frequently (at least once a week) if the vehicle is used on salty or rough roads. The vehicle should be cleaned thoroughly and carefully: cleaning that merely wets encrusted mud without removing it completely can prove damaging.
- The vehicle must be washed regularly with suitable equipment. Do not use very hot water or steam to clean the paintwork and the lower surfaces. It is advisable to soften any dirt first, then remove it with a jet of water at room temperature.

5



Important note



Do not use aggressive products for cleaning the windows. The use of aggressive products could seriously damage the bodywork.

- Do not wash the vehicle in direct sunlight or when the bodywork is still warm: make sure that the jet of water does not blast the paintwork; wash the vehicle with a sponge and a mild soap and water solution; rinse the vehicle again with a jet of water and dry it with a chamois leather.

Important note



When the vehicle has been washed, apply slight pressure to the brake pedal at moderate speed before driving at a normal speed, until the brake discs and pads have cleaned off.

In order to maintain the shine on the paintwork, polish it once or twice a year with products recommended by FERRARI.

- Any areas that are cracked or chipped by stones, scratches or parking manoeuvres, etc., must be immediately repaired by the FERRARI SERVICE NETWORK.
- Do not park the vehicle in damp and/or unventilated areas for long periods of time.

Cleaning and care of matt paintwork (optional)

Warning



The paintwork **MUST NOT** be polished using any type of product.

Owners must take great care of vehicles with matt paintwork (optional).

Here is a list of the main precautions to be taken.

- Wash the vehicle using a steam cleaner and rinse with demineralised water only.
- It must be dried using an automatic dryer or compressed air. Manual drying can **ONLY** be performed using a clean 3M microfibre yellow cloth that has been soaked in demineralised water in the areas where limescale deposits are present. The cloth must be kept in a special clean container.
- To clean any grease or oil marks, a clean 3M microfibre yellow cloth soaked in R107/S solvent (heptane) can be used. A new cloth must be used and it must not have been previously soaked in demineralised water.
- Do not wash the car in direct sunlight.
- Wash the vehicle only when the bodywork and engine are cold.
- Do not apply stickers to the bodywork.



- Any areas that are cracked or chipped by stones, scratches or parking manoeuvres, etc., must be immediately repaired by the FERRARI SERVICE NETWORK.

Important note



DO NOT lean against the vehicle especially if you are wearing clothes with buttons, buckles or are wearing rings, necklaces, etc. This may cause irreparable damage to the bodywork.

Important note



To use suitable products, contact the FERRARI SERVICE NETWORK.

Cleaning of protective anti stone-chipping film (optional)

The film has been designed to protect the bodywork: anything that damages the paint will also damage the film.

Warning



Do not pour denatured ethyl alcohol, acetone, isopropyl alcohol, heptane or substances that contain these compounds on the film.

- Do not apply adhesive elements on the film.
- When cleaning, do not use metal or abrasive substances in general and acid chemical compounds.

Important note



Avoid the film coming into contact with the brake fluid: the film will become opaque.

- Do not use solvents along the edges of the film to them from penetrating inside the adhesive layer.

Important note



Nürburgring Silver, Avus White, Alloy Grey, Met Avio, Ivory, Met Light Blue, Met Sky-Blue and Fuji White vehicles must be washed every month and waxed at least twice a year so that dirt, acid rain, pollutants, etc. do not penetrate the pores of the film and cause it to tarnish.

Important note



We recommend replacing the film every 24 months for vehicles in Nürburgring Silver, Avus White, Alloy Grey, Met Avio, Ivory, Met Light Blue, Met Sky-Blue and Fuji White, as the finish quality may deteriorate slightly (yellow tarnish) due to dirt accumulated in the porous surface of the film.

It should be noted that timely and accurate cleaning (monthly washing and waxing twice a year at least) will prevent deterioration of the film.

5



Cleaning the interior

Cleaning and care of the leather upholstery

As indicated in the “Maintenance Schedule” (see the “Warranty Booklet”), proper and regular treatment, at least once a year, will help preserve the quality, natural characteristics and softness of the leather upholstery in your FERRARI.

With this in mind, specific leather care products are also available (“Cleaner” and “Cream”) both tested by FERRARI.

These products can be ordered through the FERRARI SPARE PARTS SERVICE DEPARTMENT, both individually and as part of the “Care Kit” which includes the complete range of products for cleaning the vehicle.

Important note



For use of the “Care Kit” products, contact the FERRARI SERVICE NETWORK.

The following products must be avoided when cleaning the leather: harsh detergents, turpentine, liquid stain removers, petrol, solvents and domestic cleaning products. All of these products damage the natural material.

Cleaning and care of the Alcantara® upholstery

Warning



Do not use steam cleaners.

- Carefully dust the parts to be cleaned.
- Use a soft cloth or sponge moistened with clean water.
- Thoroughly wring out the cloth and wipe it over the entire Alcantara® area making sure you do not overwet it.
- Repeat the procedure.
- Let it dry completely.
- To recondition the material, gently use a brush with soft bristles.



If the vehicle is stored for long periods

If the vehicle is not used for long periods of time, certain precautions should be taken:

- if possible, park the vehicle on a level surface in a covered and well-ventilated area;
- prevent the vehicle from moving by engaging a gear;
- bring the tyre pressure to 3.0 bar (43.51 psi) and periodically change the point where the tyres rest on the ground;
- connect the battery conditioner (see page 198);
- protect the vehicle with a breathable fabric cover and avoid materials that prevent any dampness on the bodywork from evaporating.

Before using the vehicle again after long periods of inactivity, adjust the tyre pressure to the indicated pressure and check the fluid levels of all the systems.

Important note



If you do not intend to connect the battery to the battery conditioner, the battery must be recharged at least once every two weeks to keep certain functions, such as the radio station memory, alarm system, etc., working correctly.

The battery is an integral component of the vehicle, and required the vehicle itself to be used frequently in order to function correctly.

Infrequent vehicle usage may reduce battery performance or result in complete battery failure.

Constant usage of the specific battery conditioner provided by FERRARI for each model ensures that the original battery installed in the vehicle is kept charged correctly and in working order.

Glossary..... 225



GLOSSARY

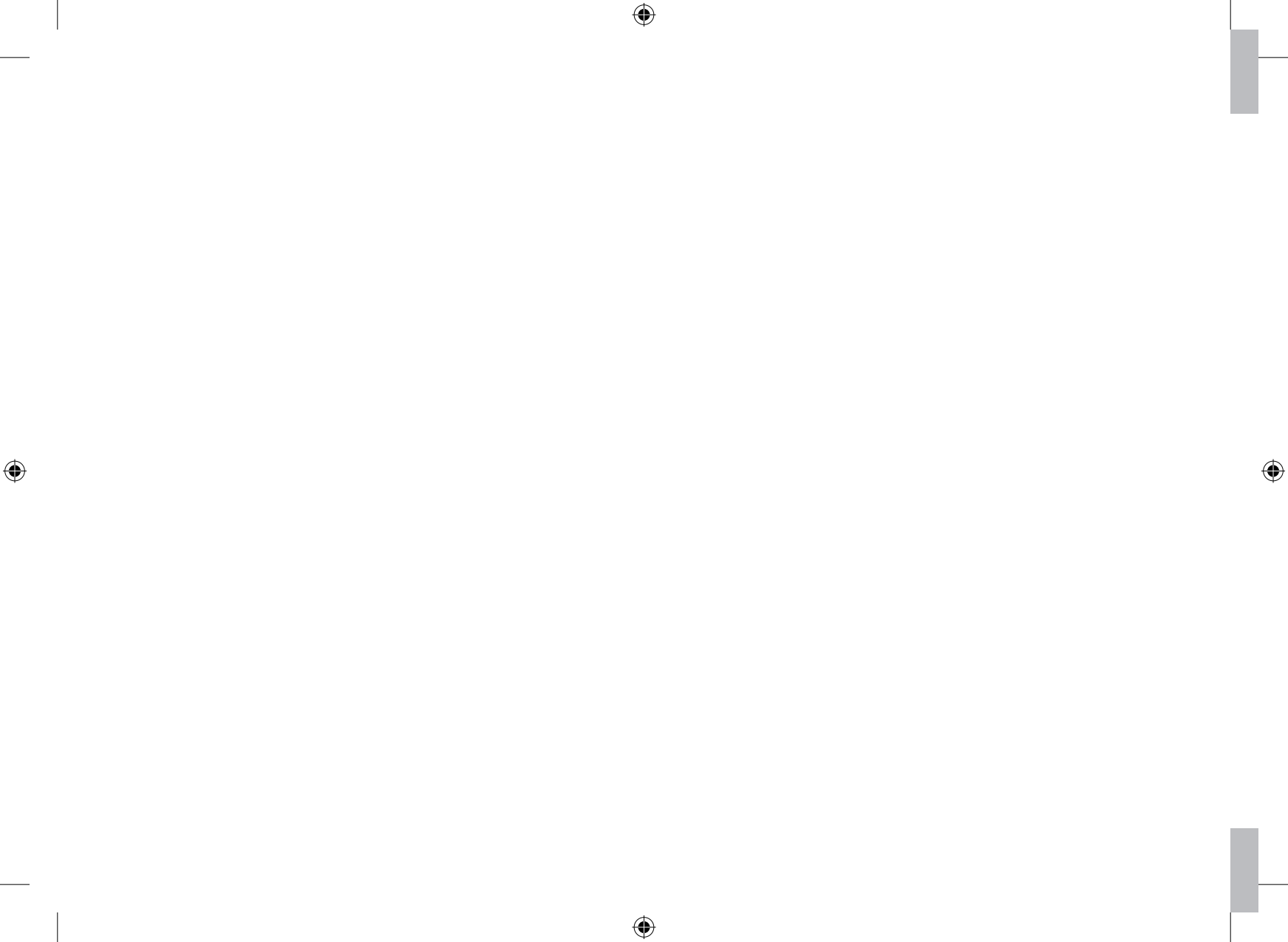



Abbreviation	Meaning
ABS	(Anti-lock Braking System) The ABS prevents wheel locking when braking so that vehicle handling can be maintained.
AC	Air conditioning.
ASR	(Antriebs Schlupf Regelung) Anti-skid regulation during acceleration.
Auto easy exit	Simplified function gear shifting. To exit “Auto easy exit” mode, simply operate one of the two shift paddles.
Autopark	Automatic activation of the electric parking brake (EPB) when the engine is switched off. This function can be disabled.
AVH	Automatic Vehicle Holding Additional function of the electric parking brake (EPB): it allows gradual release of brake shoes/pads when the vehicle starts up. This guarantees an optimised release for the vehicle and is an aid for the driver.
DCT	Dual Clutch Transmission Each clutch is associated with a part of the gearbox, one is designed for engaging even gears, the other for odd gears. Once a gear has been engaged, the system has already preselected the next one. After reaching the correct RPM, a clutch opens and at the same time the other one closes, so that the traction force is not interrupted.
Disposal	The procedure laid down in Directive 2000/53/EC and the implementation standard.
DRS	Drag Reduction System, adjustable flap on rear diffuser which reduces aerodynamic drag when open.
E-Diff 3	Evolved electronic differential integrated with the F1-Trac traction control.
EBD	(Electronic Brake-Force Distribution) Electronically-controlled brake-force distribution.
ECU	Electronic Control Unit.
EPB	Electric Parking Brake: the system operates by means of an ECU and an electric motor on the rear brake shoes.
ESC	Electronic Stability Control Consists of two systems: VDC and F1-Trac.



Abbreviation	Meaning
F1-Trac	Traction control derived from the technologies used in the racing sector. The system can estimate the maximum available grip in advance by continuously monitoring the relative wheel speed and using an auto-adaptive operating logic. Comparing this information with the vehicle dynamics model stored in the control system, F1-Trac, optimises the vehicle behaviour by controlling engine torque delivery.
FBP	(Ferrari Brake Prefill) System that eliminates the distance between the brake pads and discs by applying slight pressure to the braking system as soon as the accelerator pedal is released just before braking. This results in more immediate brake response.
Homologation	The procedure laid down in Directive 2007/46/EC and the implementation standard.
Launch Control	Strategy for performance standing starts.
Manettino	The driving mode control switch on the steering wheel that allows the driver to use vehicle potential in a quick, intuitive way.
Park Lock	Automatic DCT gearbox park lock. When the engine is off, a mechanical lock is automatically activated to prevent the vehicle from moving if the electric parking brake is not activated.
SSC	Slip Side angle Control, electronic aide slip angle control system, to ensure the maximum grip available in all situations.
TFT displays	Multifunction colour displays on the instrument panel that provide vehicle information.
TPMS	Tyre Pressure Monitoring System (optional). Using special sensors fitted inside the wheel rims next to the air valve, the data measured is sent to an ECU. The data and messages are displayed on the left TFT display.
Track (driving vehicle on)	Occasional usage of the vehicle for limited periods of time on circuits closed to public traffic to make use of the full potential of the vehicle, practice driving techniques or for learning. The vehicle is NOT intended for more frequent and continuous usage on the track.
Traction power	Force exerted by the vehicle on the road surface through the wheels; it indicates the grip.
VDC	Vehicle Dynamic Control performed through the braking system and engine torque.
Xenon headlights	Headlights on the front of the vehicle that produce a more intense beam by using a voltaic arc rather than an incandescent spiral.



6

Table of Contents 236



TABLE OF CONTENTS



Index

Symbols

12V power socket 171

A

Abbreviations 9
 ABS 58
 Activating Cruise Control 114
 Activation of electronic alarm 17
 Active aerodynamics 117
 Active aerodynamics (DRS) 117
 Active safety 41
 Adaptive headlights 128
 Adjusting display brightness 87
 Adjusting the air vents 169
 Adjusting the steering wheel 163
 AFS2 128
 Air conditioning and heating system 166
 Air conditioning controls 166
 Air recirculation 168
 Alarm memory 19
 Alarm system 15
 Auto easy exit 136
 “Auto easy exit” mode 136

Automatic gearbox 136
 “Automatic gearbox” mode 136
 Automatic Vehicle Holding 61, 149
 Autopark Function 61, 149
 Auxiliary Occupant Protection Systems 48
 AVH function 61, 149

B

Battery 194
 Battery conditioner 198
 Before a trip 130
 Brake fluid 215

C

Capless filler neck 79
 Carwash 150
 Carwash procedure 150
 Checking the battery 194
 Chronometer 91
 Chronometer operating 91
 Chronometer screen page 91
 Cleaning and care of the Alcantara upholstery 222
 Cleaning and care of the leather upholstery 222
 Cleaning the exterior 219
 Cleaning the interior 222
 Cleaning the parking sensors 99
 Cleaning the vehicle 219



Closing the engine compartment lid	74
Closing the fuel filler flap	78
Closing the luggage compartment lid	76
Clutch overheat alarm devices	200
Collapsible spare wheel	190
Configuration of vehicle parameters	86
Consulting the manual	8
Consumption	27
Controls on the steering wheel	116, 117
Controls overview	70
Coolant	214
Cruise Control (optional)	114
CT OFF mode	117, 144

D

Day lights	126
DCT gearbox oil	213
Deactivating Cruise Control	115
Deactivating the anti-lift alarm	18
Deactivation of electronic alarm	18
Deformable body	40
Dimensions	26
Disconnecting the battery	194
Display setting	86
Dome light	129
Doors	72
“Doors, engine or luggage compartment lid open” function display	103

DOWN-shifting	134
DOWN-shifting due to underrevving	134
“DOWN” shift paddle	121
Drive Away function	148
Driver and passenger airbag operating	50
Driver and passenger airbags	49
Driver-side power window	80
Driving at night	138
Driving in fog	139
Driving in the rain	138
Driving on mountain roads	139
Driving on snowy or icy roads	139
Driving style	10
Driving the vehicle	130
Driving using the driving mode control switch (“Manettino”)	142
Driving with the “ABS” braking system	140
Duplicating the keys	16

E

EBD	58
E-Diff 3	60
Electrical system	27
Electric parking brake	61, 148
Electronic alarm	17
Electronic Stability Control	59
Emergency opening of fuel filler flap	78
Emergency opening of luggage compartment lid	76



Emergency release of the electric parking brake (EPB)	202
Emergency starting	196
Emergency tyre repair and inflation kit	176
Emissions	27
Engaged gear display	111
Engine compartment lid	74
Engine malfunction alarm devices	201
Engine oil	212
Engine RPM LED on steering wheel	110
ENGINE START	116
Environmental protection	10
EPB - Electric parking brake	61, 148
ESC	59
“ESCAPE” function	101
ESC OFF mode	117, 144
Exhaust system overheating alarm devices	199
External rear-view mirrors	164
F	
F1-Trac	60
Failure of turn indicators and running lights	102
Fault display	101
FBP - Ferrari Brake Prefill	59
Ferrari CODE system	15
Flashing the headlights	124
Follow me home	128
“Follow me home” function	128

Front Lift	160
“Front Lift” system	160
Front parking sensors (activation/deactivation)	129
Fuel filler flap and neck	78
Fuel filler neck	78
Fuel inertia switch	57, 193
Fuel level	88
Fuel level gauge	88
Fuses	182

G

Gearbox display	110
Gear engaged	111
General remarks	4
Glossary	227
Glove compartment	170

H

Hazard warning lights	127
Headlight washer	122
High beams	124
Horn	120
Horn control	120
How to fasten seat belts	44
How to use the tyres	217



I

Identification and homologation plates and labels	20
If the vehicle is stored for long periods	223
Ignition switch	77
Indication of AVH system activated	111
Indication of Launch Control activated	111
Infotainment system	112
Instruments and gauges	82
Internal rear-view mirror	164

K

Key codes	14
Key lock	77
Key-on	77

L

LAUNCH button	151
Launch Control	151
Leather upholstery	222
Left TFT display	84
Left TFT display symbols	104
Level checks	210
Light bulbs	181
Lighting	124
Light switch	124
Locking and opening the doors from the inside	72
LOCK/UNLOCK	129

Low tyre pressure	63
Luggage compartment lid	75

M

MAIN	84
Main engine specifications	27
MAIN screen page	84
Maintenance	208
Maintenance of seat belts and pretensioners	46
Maintenance schedule	208
Manettino	116, 142
“Manettino” driving mode control switch	116
Manettino status	94
Manettino status screen page	94
Matt paintwork	220
MENU	86
MENU screen page	86
Ministerial homologation	19

N

Neutral	135
“N” (Neutral)	135
“N” request	135



O

OK button	84
Opening doors from the outside	72
Opening the engine compartment lid	74
Opening the fuel filler flap	78
Opening the luggage compartment lid	75

P

Parking lights	125
“Parking” mode	111
Parking sensor failure	100
Parking sensors	97
Park Lock	150
Park Lock emergency release	204
Passenger compartment accessories	170
Passenger-side power window	80
Passive safety	40
Performance	27
Performance start	151
Pocket-change compartments	170
Power steering	140
Power steering system oil	214
Power windows	80
Pretensioners	46
Push start	136

R

RACE mode	117, 143
Rain sensor	123
Rain sensor failure	123
Rear fog lights	127
Rear Parking Camera	113
“Rear Parking Camera” screen page	113
Rear-view mirrors	164
Reconnecting the battery	195
Refilling	34
Remote control batteries	17
Replacing a fuse	182
Replacing a wheel	190
Replacing light bulbs	179
Replacing remote control batteries	17
Replacing the brake pads and discs	202
Right TFT display	112
Roof panel controls	129
Running-in	130

S

Safe driving	137
Satellite alarm system	19
Seat adjustment	162
Seat belts	42
Seats	162
Sequential downshifting	134



Service	8
SETUP	84
Side airbag operating	54
Side airbags	54
Side Slip angle Control (SSC)	118, 119
“Slow Down” function	199
Spare parts	7
Special recommendations	38
“Speed limit exceeded” message	96
Speed limit setting	96
Speedometer	113
Speedometer display	112
“Speedometer” screen page	113
SPORT 2 screen page	89
SPORT mode	117, 142
SPORT screen page	89
Start button	116
Starting the engine	132
Starting the vehicle	133
State of vehicle	92
STATUS	84
Steering wheel	163
“Stop and Go” function	97
Stopping the vehicle	135
Stop&Start	152
Stop&Start failure	158
Stop&Start system (optional)	152
Sun visors	171

Super Racing seat	162
Suspension damping control	141
Suspension damping delink button	117, 146
Switching off the engine	135
System start-up	131

T

Tool bag	174
Toolkit	174
Tow hook	192
Towing	192
TPMS	62
TPMS failure	67
TPMS inactive	67
TPMS not calibrated	66
TPMS temporarily inactive	67
Transmission ratios	27
TRIP	85
TRIP A and TRIP B screen pages	95
TRIP A/B	95
Turn indicators	126
Twilight sensor	126
Tyre inflation pressure	29
Tyre puncture	64
Tyres	28
TYRES screen page	90
Tyre temperature and pressure monitoring system	62



U

Unfastening the seat belts	45
UP, DOWN, LEFT, RIGHT buttons	84
UP-shifting	134
UP-shifting due to overrevving	134
“UP” shift paddle	121
Use of the vehicle	10

V

VDA	84, 90
Vehicle Dynamic Assistance	90
Vehicle keys	14
Vehicle status screen page	92

W

Warming up the engine	133
“Warning: danger of ice” message	96
Warning lights on the panel	104
Warranty Booklet	7, 208
Weights	26
WET mode	116, 142
Wheel alignment check and adjustment	218
Wheel rims	28
While travelling	137
Windscreen and headlight washer fluid	216
Windscreen washer	122
Windscreen washer/wiper	121
Windscreen washer/wiper lever	121
Winter tyres	29

Equipment and options in FERRARI vehicle models may vary because of specific legal and market requirements. The information contained in this publication is therefore not binding in any way.

FERRARI reserves the right to make any modification to the vehicle models described in this manual, at any time, for either technical or commercial reasons.

Contact the nearest FERRARI Dealer for any further information you may require.

In the interests of efficiency and safety, as well as to preserve the value of the vehicle, we do not recommend modifying the equipment using non-approved parts.

Code no. **85314000**
Catalogue no. **4576/13**

EDITION

1st Edition **September 2013**

EDITING

STAR s.r.l.
Alessandria - Italia

PRINTING

STAR s.r.l.
Alessandria - Italia



Technical Service Department
Via Abetone Inferiore, 4
41053 Maranello
Modena - Italia